

clarion®

Owner's manual
Mode d'emploi
Manual de instrucciones
Istruzioni per l'uso

CMD5

**WATERTIGHT MARINE AM/FM/CD/MP3/WMA MULTIMEDIA
CONTROLLER**
**COMBINÉ NAUTIQUE ÉTANCHE RADIO AM/FM-
LECTEUR CD MULTIMEDIA**
**CONTROLADOR MULTIMEDIA MARINO DE AM/FM/DISCOS
CD IMPERMEABLE**
**UNITÀ DI CONTROLLO MULTIMEDIALE PER USO
MARITTIMO AM/FM/CD IMPERMEABILE**

CAUTIONS:

This appliance contains a laser system and is classified as a "CLASS 1 LASER PRODUCT". To use this model properly, read this Owner's Manual carefully and keep this manual for your future reference. In case of any trouble with this player, please contact your nearest "AUTHORIZED service station". To prevent direct exposure to the laser beam, do not try to open the enclosure.

!CAUTION

USE OF CONTROLS OR ADJUSTMENTS OR PERFORMANCE OF PROCEDURES OTHER THAN THOSE SPECIFIED IN THE OWNER'S MANUAL MAY RESULT IN HAZARDOUS RADIATION EXPOSURE.

ADVARSEL.

Denne mærkning er anbragt udvendigt på apparatet og indikerer, at apparatet arbejder med laserstråler af klasse 1, hvilket betyder, at der anvendes laserstråler af svageste klasse, og at man ikke på apparatets yderside kan blive udsat for utilsladelig kraftig stråling.

APPARATET BØR KUN ÅBNES AF FAGFOLK MED SÆRLIGT KENDSKAB TIL APPARATER MED LASERSTRÅLER!

Indvendigt i apparatet er anbragt den her gengivne advarselsmærkning, som advarer imod at foretage sådanne indgreb i apparatet, at man kan komme til at udsætte sig for laserstråling.

OBS!

Apparaten innehåller laserkomponenten som avger laserstråling överstigande gränsen för laserklass 1.

VAROITUS

Suojakoteloa si saa avata. Laite sisältää laserdiodin, joka lähettää näkymätöntä silmille vaarallista lasersäteilyä.

CE MODEL **clarion**

12V  GROUND USA: AM 530-1710kHz / FM 87.9-107.9MHz
EUROPE: AM 531-1602kHz / FM 87.5-108MHz
15A Load  AUSTRALIA: AM 531-1629kHz / FM 87.0-108MHz

THIS DEVICE COMPLIES WITH PART 15 OF THE FCC RULES.
OPERATION IS SUBJECT TO THE FOLLOWING TWO CONDITIONS:
(1) THIS DEVICE MAY NOT CAUSE HARMFUL INTERFERENCE, AND
(2) THIS DEVICE MUST ACCEPT ANY INTERFERENCE RECEIVED,
INCLUDING INTERFERENCE THAT MAY CAUSE UNDESIRABLE OPERATION.
THIS PRODUCTION COMPLIES WITH DHHS RULES 21 CFR
SUBCHAPTER J APPLICABLE AT DATE OF MANUFACTURE.

CLARION CO., LTD. 50 KAMITODA, TODA-SHI, SAITAMA-KEN, JAPAN

This product includes technology owned by Microsoft Corporation and cannot be used or distributed without a license from MSLGP.

CLASS 1 LASER PRODUCT

 **051 722 877** 

MANUFACTURED:

SERIAL No. Clarion Co., Ltd.

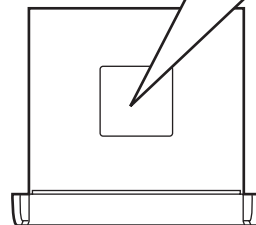

CLARION PRODUCT REGISTRATION INFORMATION

For USA and Canada only
www.clarion.com

Dear Customer:

Congratulations on your purchase of a Clarion mobile electronic product. We are confident that you'll enjoy your Clarion experience.

There are many benefits to registering your product. We invite you to visit our website at www.clarion.com to register your Clarion product.

We have made product registration simple with our easy to use website. The registration form is short and easy to complete. Once you're registered, we can keep you informed of important product information.

Register at www.clarion.com - it's easy to keep your Clarion product up to date.

Contents

1. FEATURES	3
2. PRECAUTIONS	4
Handling Compact Discs	5
Front Panel	5
3. CONTROLS	6
Names of the Buttons and their Functions	7
Major button operations when external equipment is connected to this unit	8
Display Items	9
Display Screen	9
Optional Wired Remote Control Unit Operations	10
Wireless Remote Control Unit Operations	12
4. OPERATIONS	14
Basic Operations	14
Radio Operations	15
CD/MP3/WMA Operations	17
Common Operations	21
5. ACCESSORIES	25
Sirius Satellite Operations	25
iPod Operations	28
CD Changer Operations	30
TV Operations	32
6. TROUBLESHOOTING	33
7. ERROR DISPLAYS	35
8. SPECIFICATIONS	36

1. FEATURES



- iPod® & Satellite Radio Ready + Aux Input
- Engineered Watertight & Corrosion Proof
- Wireless Remote Control Included

2. PRECAUTIONS

1. When it is very cold, the disc and the optical components may become fogged and not operate properly. Wipe fogged discs with a soft cloth. Fogged optical components will naturally return to normal when the unit is left for about one hour, after which it will operate normally.
2. When the boat is underway in rough water, the CD may skip as a result of intense vibrations and shock.
3. This unit uses a precision mechanism. Even in the event that trouble arises, never open the case, disassemble the unit, or lubricate the rotating parts.

This equipment has been tested and found to comply with the limits for a Class B digital device, pursuant to Part 15 of the FCC Rules.

These limits are designed to provide reasonable protection against harmful interference in a residential installation.

This equipment generates, uses, and can radiate radio frequency energy and, if not installed and used in accordance with the instructions, may cause harmful interference to radio communications. However, there is no guarantee that interference will not occur in a particular installation.

If this equipment does cause harmful interference to radio or television reception, which can be determined by turning the equipment off and on, the user is encouraged to consult the dealer or an experienced radio/TV technician for help.

⚠ CAUTION

USE OF CONTROLS, ADJUSTMENTS, OR PERFORMANCE OF PROCEDURES OTHER THAN THOSE SPECIFIED HEREIN, MAY RESULT IN HAZARDOUS RADIATION EXPOSURE.

THE COMPACT DISC PLAYER and MINI DISC PLAYER SHOULD NOT BE ADJUSTED OR REPAIRED BY ANYONE EXCEPT PROPERLY QUALIFIED SERVICE PERSONNEL. CHANGES OR MODIFICATIONS NOT EXPRESSLY APPROVED BY THE MANUFACTURER FOR COMPLIANCE COULD VOID THE USER'S AUTHORITY TO OPERATE THE EQUIPMENT.

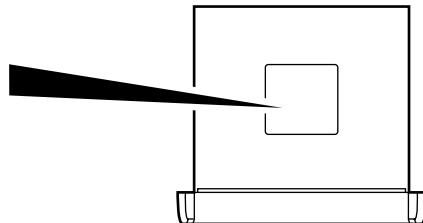

INFORMATION FOR USERS:

CHANGES OR MODIFICATIONS TO THIS PRODUCT NOT APPROVED BY THE MANUFACTURER WILL VOID THE WARRANTY AND WILL VIOLATE FCC APPROVAL.



Bottom View of Source Unit

Handling Compact Discs

Use only compact discs bearing the  or  mark.

Do not play heart-shaped, octagonal, or other specially shaped compact discs.

Some CDs recorded in CD-R/CD-RW mode may not be usable.

Handling

- Compared to ordinary music CDs, CD-R and CD-RW discs are easily affected by high temperature and humidity. Prolonged exposure to high heat and humidity may make the discs unplayable. Therefore, do not leave them for a long time in the boat.
- New discs may have rough edges. If such discs are used, the player may not work, or the sound may skip. Use a ball-point pen or the like to remove any roughness from the edge of the disc.
- Never stick labels on the surface of the compact disc or mark the surface with a pencil or pen.
- Never play a compact disc with any cellophane tape or other glue on it or with peeling off marks. If you try to play such a compact disc, you may not be able to get it back out of the CD player or it may damage the CD player.

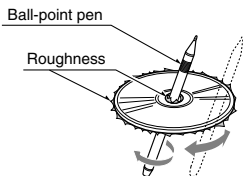

- Do not use compact discs that have large scratches, are misshapen, cracked, etc. Use of such discs may cause malfunction or damage.
- To remove a compact disc from its storage case, press down on the center of the case and lift the disc out, holding it carefully by the edges.
- Do not use commercially available CD protection sheets or discs equipped with stabilizers, etc. These may damage the disc or cause breakdown of the internal mechanism.

Storage

- Do not expose compact discs to direct sunlight or any heat source.
- Do not expose compact discs to excess humidity or dust.
- Do not expose compact discs to direct heat from heaters.

Cleaning

- To remove fingermarks and dust, use a soft cloth and wipe in a straight line from the center of the compact disc to the circumference.
- Do not use any solvents, such as commercially available cleaners, anti-static spray, or thinner to clean compact discs.
- After using special compact disc cleaner, let the compact disc dry off well before playing it.

Front Panel

⚠ CAUTION

When opening and closing the front panel, be careful not to catch your fingers. They could be injured.

- Always use this unit with the front panel closed.
- Do not force operations or use this device abnormally when opening or closing the front panel.
- Do not use the front panel as a tray to place objects on when it is open.
- When closing the front panel, do not press the [OPEN] button.

- Strong impacts to the operating or display section can cause damage or deformation.
- If the front panel does not open fully, gently open it with your hand.
- Do not touch the panel OPEN detection switch.

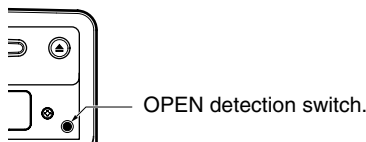

3. CONTROLS

Source unit

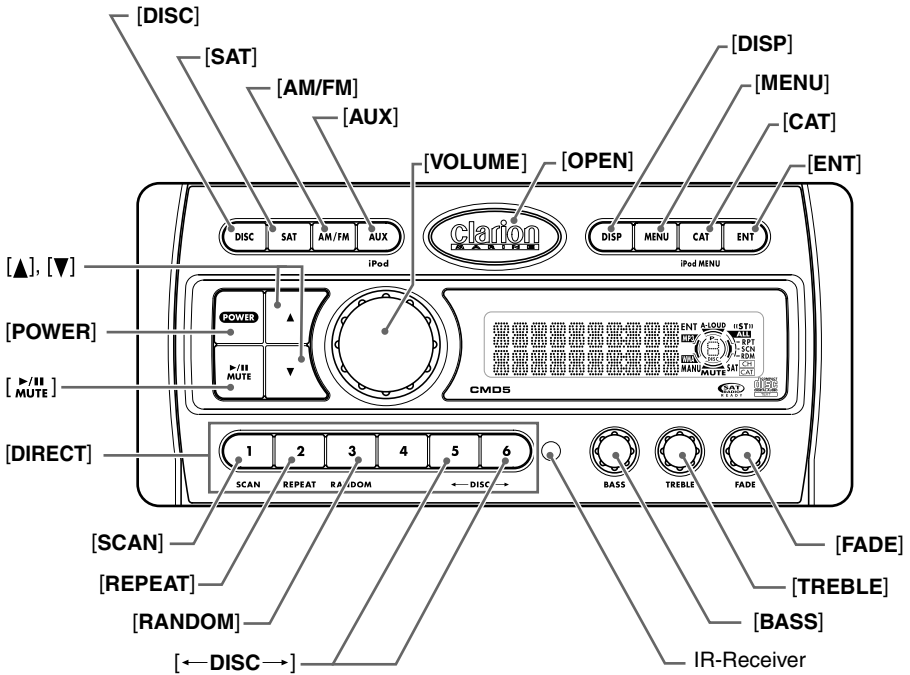

With the front panel opened

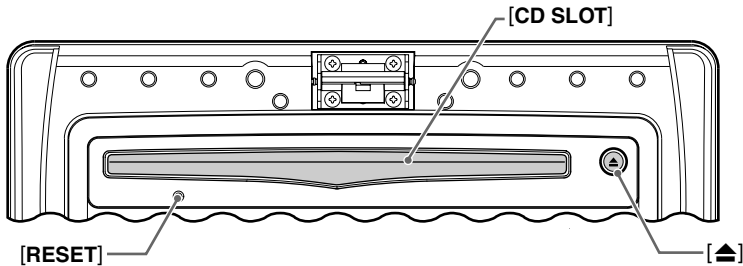

Names of the Buttons and their Functions

[DISC] (CD/CD changer) button

- Use to switch to CD/MP3 or CD changer mode.

[SAT] (Satellite) button

- Use to switch to Satellite mode.
- Switch the band.

[AM/FM] button

- Use to switch to Tuner mode or TV mode.
- Switch the band.
- Press and hold the button to switch to seek or manual tuning.

[AUX] button

- Use to switch to iPod mode or Aux mode.

[VOLUME] knob

- Adjust the volume by turning the knob right and left.
- Use the knob to perform function adjustments.

[OPEN] button

- Open the panel by pressing the “Clarion Marine” oval latch button. Audio will mute with the front panel open.

[DISP] (Display) button

- Press the button to switch the display indication.
- Press and hold the button to scroll the display.

[MENU] button

- Use to switch to the menu mode.

[CAT] (Category) button

- Enter the category selection mode.
- Use to switch to the iPod MENU mode.

[ENT] (Enter) button

- Press the button to perform preset scan.
- Press and hold the button to perform auto store.
- Press and hold the button for multi-session in CD/MP3 mode.

[FADE] (Fader) knob

- Adjust the fader by turning the knob clockwise or counterclockwise.

[TREBLE] knob

- Adjust the treble by turning the knob clockwise or counterclockwise.

[BASS] knob

- Adjust the bass by turning the knob clockwise or counterclockwise.

IR-Receiver

- Receiver for remote control unit. (Operating range: 30° in all directions)

[←-DISC→]

- The folder is up/down in MP3/WMA files.

[RANDOM] button

- Random play while in the CD/MP3 mode.
- Press and hold the button for 1 second or longer to folder random play MP3/WMA files.

[REPEAT] button

- Repeat play while in the CD/MP3 mode.
- Press and hold the button for 1 second or longer to folder repeat play MP3/WMA files.

[SCAN] button

- Play 10 seconds of each track while in the CD/MP3 mode.
- Press and hold the button for 1 second or longer to folder scan play MP3/WMA files.

[DIRECT] (1-6) buttons

- Store a station into memory or recall it directly while in the radio mode.

[] (Play/Pause/Mute) button

- Press and hold the button for 1 second or longer to play or pause.
- Turn the mute on/off.

[POWER] button

- Press the button to turn on or off the power.

[▲], [▼] (Search) buttons

- Select a station while in the radio mode or select a track while in CD/MP3 mode.
- Use to adjust function settings.
- Press and hold the button for 1 second or longer to switch to fast-forward/fast-rewind.

[CD SLOT]

- CD insertion slot.

[] (Eject) button

- Eject a CD when it is loaded into the unit.

[RESET] button

- Press and hold the button for about 2 seconds when the following symptoms occur.
 - * Nothing happens when buttons are pressed.
 - * Display is not accurate.
 - * The settings will remain in the ROM even if you turn the power off or press the reset button.

Major button operations when external equipment is connected to this unit

● When the Sirius Satellite Receiver is connected

- * For details, see the section “Sirius Satellite Operations”.

[SAT] (Satellite) button

- Use to switch to Satellite mode.
- Switch the band.

[VOLUME] knob

- Select the category in category selection mode.

[DISP] (Display) button

- Press the button to switch the display indication.
- Press and hold the button to scroll the display.

[CAT] (Category) button

- Enter the category selection mode.

[ENT] (Enter) button

- Press the button to perform category scan.
- Press and hold the button to perform preset scan.

[▲], [▼] (Search) buttons

- Select a station.

[DIRECT] (1-6) buttons

- Store a station into memory or recall it directly.

● When the CD changer is connected

- * For details, see the section “CD Changer Operations”.

[DISC] (CD/CD changer) button

- Use to switch to the CD changer mode.

[DISP] (Display) button

- Press the button to switch the display indication.
- Press and hold the button to scroll the display.

[←DISC→] (Disc up/down) buttons

- Select the desired CD in the CD changer.

[RANDOM] button

- Perform random play.
- Press and hold the button for 1 second or longer to perform disc random play.

[REPEAT] button

- Perform repeat play.
- Press and hold the button for 1 second or longer to perform disc repeat play.

[SCAN] button

- Perform scan play for 10 seconds of each track.
- Press and hold the button for 1 second or longer to perform disc scan play.

[] (Play/Pause/Mute) button

- Press and hold the button for 1 second or longer to play or pause.
- Turn the mute on/off.

[▲], [▼] (Search) buttons

- Select a track when listening to a disc.
- Press and hold the button for 1 second or longer to switch to fast-forward/fast-rewind.

● When the TV is connected

- * For details, see the selection “TV Operations”.

[AM/FM] button

- Use to switch to TV mode.
- Press and hold the button to switch between seek or manual tuning.

[ENT] (Enter) button

- Perform preset scan.
- Press and hold the button to perform auto store.

[DIRECT] (1-6) button

- Store a station into memory or recall it directly.

[▲], [▼] (Search) buttons

- Select a station.

● When the iPod is connected

- * For details, see the section “iPod Operations”.

[AUX] button

- Use to switch to the iPod mode.

[VOLUME] knob

- Use to select menus in the iPod MENU mode.

[DISP] (Display) button

- Press the button to switch the display indication.
- Press and hold the button to scroll the display.

[CAT] (iPod MENU) button

- Use to switch to the iPod MENU mode.

[SCAN]/[DIRECT] (1) button

- Use to select the **PLAYLISTS** menu in the iPod MENU mode.

[REPEAT]/[DIRECT] (2) button

- Use to select the **ARTISTS** menu in the iPod MENU mode.

[RANDOM]/[DIRECT] (3) button

- Use to select the **ALBUMS** menu in the iPod MENU mode.

[DIRECT] (4) button

- Use to select the **SONGS** menu in the iPod MENU mode.

[DIRECT] (5) button

- Use to select the **GENRES** menu in the iPod MENU mode.

[DIRECT] (6) button

- Use to select the **COMPOSERS** menu in the iPod MENU mode.

[] (Play/Pause/Mute) button

- Press and hold the button for 1 second or longer to play or pause.
- Turn the mute on/off.

[▲], [▼] (Search) buttons

- Perform the Track up or down operation.
- Press and hold the button for 1 second or longer to switch to fast-forward/fast-rewind.
- Use to proceed to the next menu in the iPod MENU mode.

Titles, frequency, clock, etc. are displayed.

* Status display may be different from the display of the control panel.

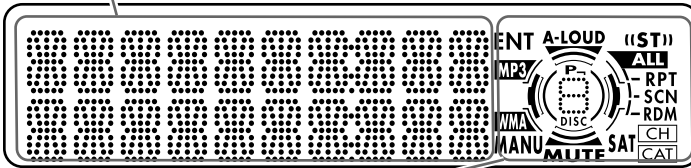

- ENT** : Enter indication
- MP3** : MP3 indication
- WMA** : WMA indication
- MANU** : Manual indication
- A-LOUD** : A-LOUD indication
- MUTE** : Mute indication
- ((ST))** : Stereo indication
- ALL** : All indication
- RPT** : Repeat indication
- SCN** : Scan indication
- RDM** : Random indication
- SAT** : Satellite indication
- CH** : Channel indication
- CAT** : Category indication
- P** : Preset channel indication (1 to 6)
- DISC** : Disc number indication (1 to 6)

Display Screen

In extreme cold, the screen movement may slow down and the screen may darken, but this is normal. The screen will recover when it returns to normal temperature.

Optional Wired Remote Control Unit Operations

■ Following operations are enabled by remote control with the separately sold Wired Remote Control Unit CMRC1 (shown below) or CMRC2.

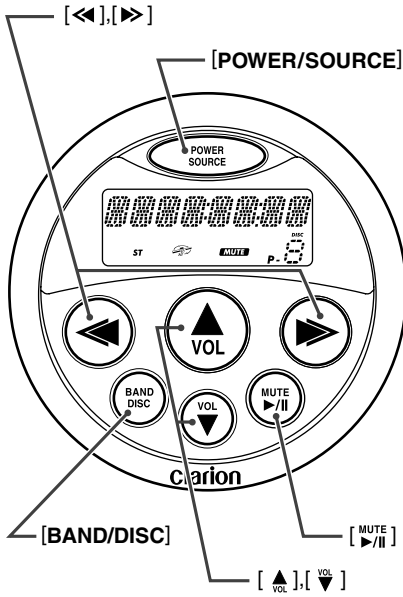

Display Items

Operation status indication*

Titles, frequency, clock, etc. are displayed.

* Status display may be different from the display of the control panel.



ST : Stereo indication

 : Satellite indication

MUTE : Mute indication

Preset channel indication (1 to 6)

Disc number indication (1 to 6)

⚠ CAUTION

Lower the volume level before powering the source unit off. The source unit stores the last volume setting. If the source unit is powered off with the volume up, when the source unit is powered back on, the sudden loud volume may harm your hearing and/or damage the source unit.

⚠ WARNING

When the front panel is open, no sound is produced, and source unit controls and remote control unit operations are disabled. Always shut the front panel after changing the CD.
EXPOSING THE UNIT TO WATER WITH THE FRONT PANEL OPEN WILL CAUSE DAMAGE OR UNIT MALFUNCTION!

[POWER/SOURCE] button

Turning on and off the power

Press the [SOURCE] button to turn the power on and press and hold it for 1 second or longer to turn the power off.

Changing the operation mode

Each time the [SOURCE] button is pressed, the mode switches in the following order:

Radio mode → Satellite mode → CD/MP3 mode → iPod mode → CD changer mode → TV mode → AUX mode → Radio mode.....

Note:

- If the above equipment is not connected, corresponding mode cannot be selected.

[▲], [▼] buttons

Adjusting the volume

Press the [▲] button to increase the volume and press the [▼] button to decrease the volume.

[BAND/DISC] button

Changing the band (in Radio mode)

Each time the [BAND] button is pressed, the band switches in the following order:

FM1 → FM2 → FM3 → AM → FM1.....

Changing the band (in Satellite mode)

Each time the [BAND] button is pressed, the band switches in the following order:

SR1 → SR2 → SR3 → SR1.....

Changing the band (in TV mode)

Each time the [BAND] button is pressed, the band switches in the following order:

TV1 → TV2 → TV1.....

Tuning (in Radio mode or TV mode)

Press and hold the [BAND] button for 1 second or longer to switch between seek tuning and manual tuning.

Top function (in CD/MP3 mode)

Press the [BAND] button, then the CD will start from the first track of the folder.

Changing the disc (in CD changer mode)

Each time the [BAND] button is pressed, the disc switches in the following order:

1 → 2 → 3 → 4 → 5 → 6 → 1.....

[MUTE] button

Press the [MUTE] button. The sound is muted immediately. To cancel, press the [MUTE] button again.

Press and hold the button for 1 second or longer to play or pause in CD/MP3, iPod, and CD changer mode.

[◀], [▶] buttons

Selecting tracks (in CD changer mode, CD/MP3 mode or iPod mode)

Press the [▶] button to start playback from the beginning of the following track. Press the [◀] button to start playback from the beginning of the current track. If pressed again, the track moves to the previous one.

Fast-forward and fast-rewind (in CD changer mode, CD/MP3 mode or iPod mode)

Press and hold the [▶] button to fast-forward the disc. Press and hold the [◀] button to fast-rewind the disc.

- * Pressing and holding the [◀] or [▶] button for 1 second or longer will move forward or backward faster than normal play, and pressing and holding it for 3 seconds or longer will do the operation even faster.

Selecting desired stations (in Radio mode, Satellite mode or TV mode)

Press the [◀] or [▶] button to tune in a station for seek tuning or manual tuning (Radio mode/TV mode only).

Wireless Remote Control Unit Operations

- Following operations are enabled by remote control with the Wireless Remote Control Unit RCB-176-600.

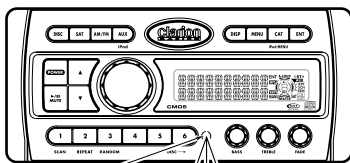

Receiver for wireless remote control unit

Operating range:
30° in all directions

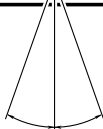

Wireless remote control unit

Note:

- Wireless Remote Control is not Waterproof. Please avoid Contact with Water.

Signal transmitter

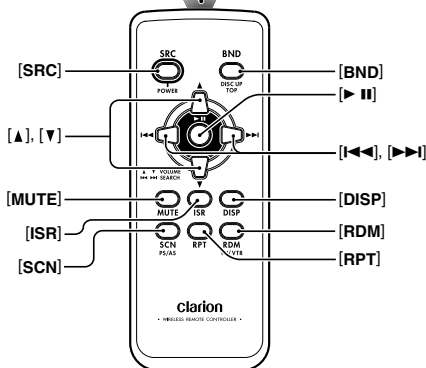

Inserting the Battery

1. Turn over the remote control unit and slide the cover in the direction indicated by the arrow in the illustration.
2. Insert the battery (CR2025) into the insertion guides, with the printed side (+) facing upwards.
3. Press the battery in the direction indicated by the arrow so that it slides into the compartment.
4. Replace the cover and slide in until it clicks into place.

Notes:

Misuse may result in rupture of the battery, producing leakage of fluid and resulting in personal injury or damage to surrounding materials. Always follow these safety precautions:

- Use only the designated battery.
- When replacing the battery, insert properly, with +/- polarities oriented correctly.
- Do not subject battery to heat, or dispose of in fire or water. Do not attempt to disassemble the battery.
- Dispose of used batteries properly.

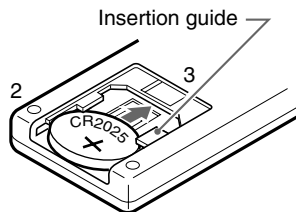
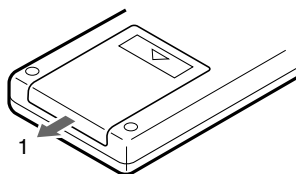

⚠ WARNING

Alkaline(CR) button batteries contain Perchlorate.
--Don't put in Trash-- Dispose as Hazardous Waste.

Mode Button	Radio/Satellite	CD/MP3	CD changer	TV	iPod
[SRC]	Switches among radio, Sirius Satellite Receiver, CD/MP3, iPod, CD changer, TV and AUX. The power of this unit turns off by pressing and holding for 1 second or longer when the power is on.				
[BND]	Switches reception band. When pressed and held for 1 second or longer: Seek tuning/manual tuning (radio mode only).	Returns to the first track or the first track of the folder (MP3/WMA).	Moves the next disc in increasing order.	Switches reception band. When pressed and held for 1 second or longer: Seek tuning/manual tuning.	No function.
[▲], [▼]	Increases and decreases volume (in all modes).				
[◀◀], [▶▶]	Seeks stations up and down for seek/manual tuning (radio mode only).	Moves tracks up and down. When pressed and held for 1 second or longer: Fast-forward/fast-rewind.		Seeks stations up and down for seek/manual tuning.	Moves tracks up and down. When pressed and held for 1 second or longer: Fast-forward/fast-rewind.
[▶]	No function.	Switches between playback and pause.		No function.	Switches between playback and pause.
[MUTE]	Turns mute on and off.				
[ISR]	No function.				
[DISP]	Switches displays.				
[SCN]	Preset scan. When pressed and held for 2 seconds or longer: Auto store (radio mode only). ^{*1}	Scan play. When pressed and held for 1 second or longer: Folder scan (MP3/WMA).	Scan play. When pressed and held for 1 second or longer: Disc scan play.	Preset scan. When pressed and held for 2 seconds or longer: Auto store.	No function.
[RPT]	No function.	Repeat play. When pressed and held for 1 second or longer: Folder repeat (MP3/WMA).	Repeat play. When pressed and held for 1 second or longer: Disc repeat play.	No function.	Repeat play. When pressed and held for 1 second or longer: All repeat play.
[RDM]	No function.	Random play. When pressed and held for 1 second or longer: Folder random (MP3/WMA).	Random play. When pressed and held for 1 second or longer: Disc random play.	Switches between TV and VTR.	Random play. When pressed and held for 1 second or longer: All random play.

* Some of the corresponding buttons on the main unit and remote control unit have different functions.

*1: For satellite mode, performs category scan. When pressed and held for 2 seconds or longer: preset scan.

4. OPERATIONS

Basic Operations

Note:

- Be sure to read this chapter referring to the front diagrams of chapter "3. CONTROLS" on page 6.

⚠ CAUTION

Lower the volume level before powering the source unit off. The source unit stores the last volume setting. If the source unit is powered off with the volume up, when the source unit is powered back on, the sudden loud volume may harm your hearing and/or damage the source unit.

⚠ WARNING

When the front panel is open, no sound is produced, and source unit controls and remote control unit operations are disabled. Always shut the front panel after changing the CD.

EXPOSING THE UNIT TO WATER WITH THE FRONT PANEL OPEN WILL CAUSE DAMAGE OR UNIT MALFUNCTION!

Turning on/off the power

1. Press the [POWER] button.
2. The illumination and display on the unit light up. The unit automatically remembers its last operation mode and will automatically switch to display that mode.
3. Press the [POWER] button to turn off the power for the unit.

Note:

- **System check**
During the initial power up of this unit, it will go through a system check procedure. This procedure verifies any devices connected through CeNET. Any additional CeNET devices plugged into the unit after the initial power up will initiate the system check procedure. The system check starts automatically within the unit.

Selecting a mode

Press the [DISC], [SAT], [AM/FM] or [AUX] button to change the operation mode.

- * External equipment not connected with CeNET is not displayed.

Adjusting the volume

Turning the [VOLUME] knob clockwise increases the volume; turning it counterclockwise decreases the volume.

- * The volume level is from 0 (minimum) to 33 (maximum).

Switching the display

Press the [DISP] button to select the desired display.

The display changes each time you press the [DISP] button.

- * The display status varies depending on the mode you selected. For more information, refer to chapters of the each operation mode.

Adjusting the bass

Turning the [BASS] knob clockwise emphasizes the bass; turning it counterclockwise attenuates the bass.

- * Adjustment range: -8 to +8 dB

Adjusting the treble

Turning the [TREBLE] knob clockwise emphasizes the treble; turning it counterclockwise attenuates the treble.

- * Adjustment range: -7 to +7 dB

Adjusting the fader

Turning the [FADE] knob clockwise emphasizes the sound from the front speakers; turning it counterclockwise emphasizes the sound from the rear speakers. The fader adjusts both the source unit RCA and speaker outputs.

- * Adjustment range: F12 (full front) to R12 (full rear)

Changing the reception area

This unit is initially set to USA frequency intervals of 10 kHz for AM and 200 kHz for FM. When using it outside the USA, the frequency reception range can be switched to the intervals below.

		U.S. standard	Other countries	Europe standard
AM	Frequency spacing	10 kHz	9 kHz	9 kHz
	Frequency range	530 to 1,710 kHz	531 to 1,629 kHz	531 to 1,602 kHz
FM	Frequency spacing	200 kHz	50 kHz	50 kHz
	Frequency range	87.9 to 107.9 MHz	87.0 to 108 MHz	87.5 to 108 MHz

Setting the reception area

* All station preset memories are lost when the reception area is changed.

1. Press the [AM/FM] button and select the desired radio band (FM or AM).
 - **U.S. standard (initial setting for US model)**
2. While pressing the [DISP] button, press and hold the number "1" of the [DIRECT] buttons for 2 seconds or longer.
 - **Other countries (new setting)**
3. While pressing the [DISP] button, press and hold the number "2" of the [DIRECT] buttons for 2 seconds or longer.
 - **Europe standard (initial setting for Europe model)**
4. While pressing the [DISP] button, press and hold the number "3" of the [DIRECT] buttons for 2 seconds or longer.

Listening to the radio

1. Press the [AM/FM] button to select the radio mode. The frequency appears on the display.
2. Press the [AM/FM] button to select the radio band. Each time the button is pressed, the radio reception band changes in the following order:
FM1 → FM2 → FM3 → AM → FM1...
3. Press the [▲] or [▼] button to tune in the desired station.

Mute

Use this function to turn off the sound immediately.

1. Press the [MUTE] button. The sound turns off and "MUTE" appears on the display.
2. Press the [MUTE] button again to cancel the mute mode.

Tuning

There are 3 types of tuning modes available, seek tuning, manual tuning and preset tuning.

Seek tuning

1. Press the [AM/FM] button and select the desired band (FM or AM).
 - * If "MANU" is lit on the display, press and hold the [AM/FM] button. "MANU" on the display goes off, and seek tuning is now available.
2. Press the [▲] or [▼] button to automatically seek a station.

When the [▲] button is pressed, the station is sought in the direction of higher frequencies; if the [▼] button is pressed, the station is sought in the direction of lower frequencies.

Manual tuning

There are 2 manual tuning methods available: Quick tuning and step tuning.

When you are in the step tuning mode, the frequency changes one step at a time. In the quick tuning mode, you can quickly tune the desired frequency.

1. Press the [AM/FM] button and select the desired band (FM or AM).
 - * If "MANU" is not lit on the display, press and hold the [AM/FM] button. "MANU" is lit on the display and manual tuning is now available.
2. Tune in a station.

● Quick tuning

Press and hold the [▲] or [▼] button for 1 second or longer to tune in a station.

● Step tuning

Press the [▲] or [▼] button to manually tune in a station.

Recalling a preset station

A total of 24 preset positions (6-FM1, 6-FM2, 6-FM3, 6-AM) exist to store individual radio stations in memory. Pressing the corresponding [DIRECT] button recalls the stored radio frequency automatically.

1. Press the [AM/FM] button and select the desired band (FM or AM).
2. Press the corresponding [DIRECT] button to recall the stored station.
 - * Press and hold one of the [DIRECT] buttons for 2 seconds or longer to store the current station into preset memory.

Manual memory

1. Select the desired station with seek tuning, manual tuning or preset tuning.
2. Press and hold one of the [DIRECT] buttons for 2 seconds or longer to store the current station into preset memory.

Auto store

Auto store is a function for storing up to 6 stations that are automatically tuned in sequentially. If 6 receivable stations cannot be received, a previously stored stations remain at the memory position.

1. Press the [AM/FM] button and select the desired band (FM or AM).
2. Press and hold the [ENT] button for 2 seconds or longer. The stations with good reception are stored automatically to the preset channels.

Preset scan

Preset scan receives the stations stored in preset memory in order. This function is useful when searching for a desired station in memory.

1. Press the [ENT] button.
2. When a desired station is tuned in, press the [ENT] button again to continue receiving that station.

Note:

- *Be careful not to press and hold the [ENT] button for 2 seconds or longer, otherwise the auto store function is engaged and the unit starts storing stations.*

MP3/WMA

What is MP3?

MP3 is an audio compression method and classified into audio layer 3 of MPEG standards. This audio compression method has penetrated into PC users and become a standard format. This MP3 features the original audio data compression to about 10 percent of its initial size with a high sound quality. This means that about 10 music CDs can be recorded on a CD-R disc or CD-RW disc to allow a long listening time without having to change CDs.

What is WMA?

WMA is the abbreviation of Windows Media Audio, an audio file format developed by Microsoft Corporation.

Notes:

- If you play a file with DRM (Digital Rights Management) for WMA remaining ON, no audio is output (The WMA indicator blinks).
- Windows Media™, and the Windows® logo are trademarks, or registered trademarks of Microsoft Corporation in the United States and/or other countries.

● To disable DRM (Digital Rights Management)

1. When using Windows Media Player 9, click on TOOL → OPTIONS → MUSIC RECORD tab, then under Recording settings, uncheck the Check box for RECORD PROTECTED MUSIC. Then, reconstruct files.
Personally constructed WMA files are used at your own responsibility.
2. When using Windows Media Player 10, click on TOOLS → OPTIONS → RIP MUSIC tab, then under RIP SETTINGS, uncheck the Check box for COPY PROTECT MUSIC. Then, reconstruct files.
Personally constructed WMA files are used at your own responsibility.

Precautions when creating MP3/WMA files

● Usable sampling rates and bit rates

- MP3: Sampling rate 11.025 kHz-48 kHz, Bit rate 8 kbps-320 kbps / VBR
- WMA: Bit rate 48 kbps-192 kbps

● File extensions

- Always add a file extension “.MP3” or “.WMA” to MP3 or WMA file by using single byte letters. If you add a file extension other than specified or forget to add the file extension, the file cannot be played.
- Files without MP3/WMA data will not play. The indication “--:--” appears in the play time display if you attempt to play files without MP3/WMA data.

● Logical format (File system)

- When writing MP3/WMA file on a CD-R disc or CD-RW disc, please select “ISO9660 level 1, 2 or JOLIET or Romeo” as the writing software format. Normal play may not be possible if the disc is recorded on another format.
- The folder name and file name can be displayed as the title during MP3/WMA play but the title must be within 128 single byte alphabetical letters and numerals (including an extension).
- Do not affix a name to a file inside a folder having the same name.

● Folder structure

- A disc with a folder having more than 8 hierarchical levels will be impossible.

● Number of files or folders

- Up to 255 files can be recognized per folder. Up to 512 files can be played.
- Tracks are played in the order that they were recorded onto a disc (Tracks might not always be played in the order displayed on the PC).
- Some noise may occur depending on the type of encoder software used while recording.

CD/MP3/WMA Operations

Multi-session function

When a disc contains both normal CD type tracks and MP3/WMA type tracks, you can select which type of the recorded tracks to play.

● Switching mixed mode

Each time you press and hold the [ENT] button for 1 second or longer, the mixed mode is switched between MULTI-SESS CD and MULTI-SESS MP3.

- Types of recording that can be played are as follows:

Setting	Set to MULTI-SESS CD (Default value)	Set to MULTI-SESS MP3
Disc		
Mixed with CD and MP3/WMA type tracks	Play CD	Play MP3/WMA
CD type track only	Play CD	Play CD
MP3/WMA type track only	Play MP3/WMA	Play MP3/WMA

- After making these settings, remove the disc and then reinsert it.

Notes:

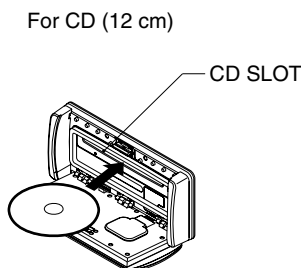

- When playing a CDD (Copy Control CD), set the setting to CD type. When this is set to MP3/WMA type, the CD cannot be played normally in some cases.
- When playing the disc (contains CD tracks and MP3/WMA type tracks), there is no sound for MP3 type tracks if the setting "MULTI-SESS CD" is selected. Press the [▲] or [▼] button to select another type.

Loading a CD



Insert a CD into the center of the CD SLOT with the label side facing up. While loading, "FILE READ" appears on the display; then the CD plays automatically.

Notes:

- Never insert foreign objects into the CD SLOT.
- If the CD is not inserted easily, there may be another CD in the mechanism or the unit may require service.
- Discs not bearing the  or  mark and CD-ROMs cannot be played by this unit.
- Some CDs recorded in CD-R/CD-RW mode may not be usable.

Backup Eject function

Just pressing the [▲] button ejects the disc even if the power to the unit was not turned on.

Press the [▲] button and remove it when ejected.

⚠ CAUTION

- Do not try to put your hand or fingers in the CD SLOT. Also never insert foreign objects into the slot.
- Do not insert discs where adhesive comes out from cellophane tape or rental CD label, or discs with marks where cellophane tape or rental CD labels were removed. It may be impossible to extract these discs from the unit and they may cause the unit to break down.

Listening to a disc already loaded in the unit

Press the [DISC] button to select the CD/MP3 mode.

When the unit enters the CD/MP3 mode, play starts automatically.

- * If there is no disc loaded, "NO DISC" appears on the display.

Pausing play

Press and hold the [MUTE] button to pause play. "PAUSE" appears on the display.

To resume CD play, press and hold the [MUTE] button again.

Displaying titles

This unit can display title data for CD-text/MP3/WMA disc with this unit.

Each time you press the [DISP] button, the display changes in the following order:

● CD-text disc

TRACK (Track name) and T01 00:00 (Track No./Play time) → DISC (Disc title) and ARTIST (Artist title) → Clock Display → TRACK (Track title) and T01 00:00 (Track No./Play time)...

● MP3/WMA disc

TRACK (File name) and T01 00:00 (Track No./Play time) → FOLDER (Folder name) and F01 00:00 (Folder No./Play time) → TITLE (Title TAG) and ALBUM (Album TAG) → ARTIST (Artist TAG) → Clock Display → TRACK (File name) and T01 00:00 (Track No./Play time)...

Notes:

- If the CD playing is not a CD-text CD has been input, "NO TITLE" appears on the display.
- If MP3/WMA disc is not input TAG, "NO TITLE" appears on the display.
- For MP3, supports ID3 Tags V2.3 / 2.2 / 1.1 / 1.0.
- Tag displays give priority to V2.3 / 2.2.
- In the case of album Tags for WMA, the information written into the extension header is displayed.
- Only ASCII characters can be displayed in Tags.

Selecting a track

● Track-up

1. Press the [▲] button to move ahead to the beginning of the next track.
2. Each time you press the [▲] button, the track advances ahead to the beginning of the next track.

● Track-down

1. Press the [▼] button to move back to the beginning of the current track.
2. Press the [▼] button twice to move to the beginning of the previous track.

Fast-forward/fast-rewind

● Fast-forward

Press and hold the [▲] button for 1 second or longer.

● Fast-rewind

Press and hold the [▼] button for 1 second or longer.

- * For MP3/WMA discs, it takes some time until the start of searching and between tracks. In addition, the playing time may have a margin of error.

Folder select

This function allows you to select a folder containing MP3/WMA files and start playing from the first track in the folder.

1. Press the [5] or [6] button.
 - Press the [6] button to move to the next folder. Press the [5] button to move to the previous folder.
 - * Press the [6] button while in the final folder to shift to the first folder.
 - * Folder without an MP3/WMA file is not selectable.
2. To select a track, press the [▲] or [▼] button.

Scan play

This function allows you to locate and play the first 10 seconds of all the tracks recorded on a CD.

1. Press the [SCAN] button.
 - * Scan play starts from the next track after the track currently being played back.
2. To cancel scan play, press the [SCAN] button again.

Folder scan play

This function allows you to locate and play the first 10 seconds of the first track of all the folders on an MP3/WMA disc.

1. Press and hold the [SCAN] button for 1 second or longer.
 - * Folder scan play starts from the next track after the track currently being played back.
2. To cancel folder scan play, press the [SCAN] button again.

Repeat play

This function allows you to play the current track repeatedly.

1. Press the **[REPEAT]** button.
2. To cancel repeat play, press the **[REPEAT]** button again.

Folder repeat play

This function allows you to play a track in the folder currently being played back in the MP3/WMA disc repeatedly.

1. Press and hold the **[REPEAT]** button for 1 second or longer.
2. To cancel folder repeat play, press the **[REPEAT]** button again.

Random play

This function allows you to play all tracks recorded on a CD; and all tracks in the folder (currently being played back in the MP3/WMA disc) in a random order.

1. Press the **[RANDOM]** button.
2. To cancel random play, press the **[RANDOM]** button again.

Folder random play

This function allows you to play all tracks of all the folders recorded on an MP3/WMA disc in a random order.

1. Press and hold the **[RANDOM]** button for 1 second or longer.
2. To cancel folder random play, press the **[RANDOM]** button again.

AUX function

This system has rear RCA cables so you can listen to sounds and music from an external device connected to this unit.

Cellular telephone mute

This unit requires special wiring to mute the audio signal automatically when a cellular telephone rings.

* This function is not compatible with all cellular telephones. Contact your local authorized Clarion dealer for information on proper installation and compatibility.

Changing the adjustment setting

1. Press the [MENU] button to switch to the adjustment selection display.
2. Press the [▲] or [▼] button to select the adjustment item.
Each time you press the [▲] or [▼] button, the adjustment item changes as following order:
"DIMMER" → "CLOCK" → "LOUD" → "NF VOL" → "SID DISP" → "TV/VTR" → "TV AREA" → "TV DIVER" → "AUX SENS" → "CONTRAST" → "SCROLL" → "A-CANCEL" → "TEL-SEL" → "TEL-SP" → "TEL-SW" → "RESET" → "SYSTEM CHECK" → "DIMMER"...
3. Turn the [VOLUME] knob to adjust the selected setting.
 - * When "ENT" is blinking on the display, press the [ENT] button to adjust the setting value.
4. After the adjustment is complete, press the [MENU] button to return to the previous mode.

Notes:

- The adjustment setting is canceled when not operating for more than 10 seconds (except Clock and Sirius ID setting).
- When each mode is selected, the item shown in grey will be displayed.

Dimmer Control

You can set the dimmer control.

* The factory default setting is "OFF".

1. Press the [MENU] button to switch to the menu mode.
2. Press the [▲] or [▼] button to select "DIMMER".
3. Turn the [VOLUME] knob to select "ON" or "OFF".
4. Press the [MENU] button to return to the previous mode.

Setting the clock

1. Press the [MENU] button to switch to the menu mode.
2. Press the [▲] or [▼] button to select "CLOCK".
3. Press the [ENT] button.
4. Press the [▲] or [▼] button to select the hour or the minute.
5. Turn the [VOLUME] knob to set the correct time.
 - * The clock is displayed in 12-hour format.
6. Press the [ENT] button to store the time into memory.
7. Press the [MENU] button to return to the previous mode.

Note:

- You cannot set the clock when it is displayed with only the ignition on. If you drain or remove the boat's battery or take out this unit, the clock is reset. While setting the clock, if another button or operation is selected, the clock set mode is canceled.

Setting the loudness

* The factory default setting is "ON".

1. Press the [MENU] button to switch to the menu mode.
2. Press the [▲] or [▼] button to select "LOUD".
3. Turn the [VOLUME] knob to select "ON" or "OFF".
4. Press the [MENU] button to return to the previous mode.

Common Operations

Adjusting the non-fade volume

* The factory default setting is "NFVOL +6".
(Adjustment range: -6 to +6)

1. Press the [MENU] button to switch to the menu mode.
2. Press the [▲] or [▼] button to select "NF VOL".
3. Turn the [VOLUME] knob to adjust the nonfader volume.
4. Press the [MENU] button to return to the previous mode.

Verifying your SIRIUS ID (Sirius mode only)

1. Press the [MENU] button to switch to the menu mode.
2. Press the [▲] or [▼] button to select "SID DISP".
3. Press the [ENT] button.
The source unit displays the high-order 6 digits of the SIRIUS ID in the Operation status information.
4. Turn the [VOLUME] knob clockwise to change the low-order 6 digits of the SIRIUS ID.
To display the high-order 6 digits of the SIRIUS ID again, turn the [VOLUME] knob counterclockwise.
5. Press the [ENT] button.
6. Press the [MENU] button to return to the previous mode.

Switching TV/VTR mode (TV mode only)

This function switches TV to VTR.

1. Press the [MENU] button to switch to the menu mode.
2. Press the [▲] or [▼] button to select "TV/VTR".
3. Press and hold the [ENT] button to select TV or VTR.

Setting the TV area (TV mode only)

The TV tuner area setting changes by the TV area you selected.

1. Press the [MENU] button to switch to the menu mode.
2. Press the [▲] or [▼] button to select "TV AREA".
3. Turn the [VOLUME] knob to select the reception area.
4. Press the [MENU] button to return to the previous mode.

The above operations are required when a TV tuner other than TTX7501z is connected.

Setting the TV diver (TV mode only)

You can change the reception setting for the TV antenna connected to the TV tuner.

1. Press the [MENU] button to switch to the menu mode.
2. Press the [▲] or [▼] button to select "TV DIVER".
3. Turn the [VOLUME] knob to set the setting to "ON" or "OFF".
 - ON:
Sets reception emphasizing the visual.
 - OFF:
Sets the diver setting to OFF.
4. Press the [MENU] button to return to the previous mode.

Selecting AUX IN sensitivity (AUX mode only)

Make the following settings to select the sensitivity when sounds from external devices connected to this unit are difficult to hear even after adjusting the volume.

* The factory default setting is "MID".

1. Press the [MENU] button to switch to the menu mode.
2. Press the [▲] or [▼] button to select "AUX SENS".
3. Turn the [VOLUME] knob to select from "HIGH", "MID" or "LOW".
4. Press the [MENU] button to return to the previous mode.

Note:

- For telephone interrupt, AUX SENS is always "MID".

Adjusting the display contrast

You can adjust the display contrast to match the angle of installation of the unit.

* The factory default setting is "4". (Adjustment level: 1 to 8)

1. Press the [MENU] button to switch to the menu mode.
2. Press the [▲] or [▼] button to select "CONTRAST".
3. Turn the [VOLUME] knob to adjust the contrast.
4. Press the [MENU] button to return to the previous mode.

Setting the method for title scroll

Set how to scroll in CD-text, MP3/WMA title.

* The factory default setting is "ON".

1. Press the [MENU] button to switch to the menu mode.
2. Press the [▲] or [▼] button to select "SCROLL".
3. Turn the [VOLUME] knob to set the setting to "ON" or "OFF".
 - **ON:**
Scrolls automatically.
 - **OFF:**
Scrolls just 1 time when the title was changed.
4. Press the [MENU] button to return to the previous mode.

Amplifier cancel setting

Set the internal amplifier on or off.

* The factory default setting is "OFF".

1. Press the [MENU] button to switch to the menu mode.
2. Press the [▲] or [▼] button to select "A-CANCEL".
3. Turn the [VOLUME] knob to set the setting to "ON" or "OFF".
 - **ON:**
Amplifier is turned-off.
 - **OFF:**
Amplifier is turned-on.
4. Press the [MENU] button to return to the previous mode.

Selecting AUX/CeNET

* The factory default setting is "AUX".

1. Press the [MENU] button to switch to the menu mode.
2. Press the [▲] or [▼] button to select "TEL-SEL".
3. Turn the [VOLUME] knob to select "AUX" or "CENET".
 - **AUX:**
You can listen to telephone calls from the AUX input.
(with Bluetooth BB (BLT370) connected)
 - **CENET:**
You can listen to telephone calls from the CeNET input.
(with Bluetooth BB (BLT433) connected)
4. Press the [MENU] button to return to the previous mode.

Setting the speaker output for the cellular phone (Optional Bluetooth BB (BLT370/433))

* The factory default setting is "RIGHT".

* To output the telephone calls, set the cellular phone interrupt to ON.

1. Press the [MENU] button to switch to the menu mode.
2. Press the [▲] or [▼] button to select "TEL-SP".
3. Turn the [VOLUME] knob to select "RIGHT" or "LEFT".
 - **RIGHT:**
Telephone calls can be heard on the front right speaker connected to this unit.
 - **LEFT:**
Telephone calls can be heard on the front left speaker connected to this unit.
4. Press the [MENU] button to return to the previous mode.

Cellular phone interrupt setting

If you connect this unit and your cellular phone with a separately sold unit (Bluetooth BB (BLT370/433)), you can listen to your telephone calls on your speakers.

* The factory default setting is "OFF".

1. Press the [MENU] button to switch to the menu mode.
 2. Press the [▲] or [▼] button to select "TEL-SW".
 3. Turn the [VOLUME] knob to select "OFF", "ON" or "MUTE".
 - **OFF:**
Cellular phone interrupt does not work.
 - **ON:**
You can listen to your telephone calls from the speakers connected to this unit.
- Notes:**
- If connecting Bluetooth BB (BLT370/433), please ensure the setting is ON to receive the telephone audio through the system.
 - When listening to your calls on your speakers, you can adjust the volume by the [VOLUME] knob.
- **MUTE:**
The sound from this unit is muted during telephone calls.
4. Press the [MENU] button to return to the previous mode.

Performing memory reset

This function allows you to reset adjusted settings in the ROM.

The stored settings like preset channels, adjusted areas, ISR memories, adjust mode settings and sound mode settings can be formatted by this function.

Note:

• *The settings will remain in the ROM even if you turn the power off or press the reset button.*

1. Press the [MENU] button to switch to the menu mode.
2. Press the [▲] or [▼] button to select “RESET”.
3. Press and hold the [ENT] button.
The power will be turned off automatically.

Performing a system check

This function verifies the devices hooked up through CeNET.

1. Press the [MENU] button to switch to the menu mode.
2. Press the [▲] or [▼] button to select “SYSTEM CHECK”.
3. Press and hold the [ENT] button for 1 second or longer.
CeNET connection configuration is automatically checked.
When the system check is complete, the display returns to the previous mode.

5. ACCESSORIES

Sirius Satellite Operations

■ Requires additional SIR-CL3M CeNET module.

What is Sirius Satellite? SIRIUS R E A D Y

Sirius is radio the way it was meant to be: Up to 100 new channels of digital quality programming delivered to listeners coast to coast via satellite. That means 50 channels of completely commercial-free music. Plus up to 50 more channels of news, sports, and entertainment from names like CNBC, Discovery, SCI-FI Channel, A&E, House of Blues, E!, NPR, Speedvision and ESPN.

Sirius is live, dynamic entertainment, completely focused on listeners. Every minute of every day of every week will be different. All 50 commercial-free music channels are created inhouse and hosted by DJs who know and love the music. Do you like Reggae? How about Classic Rock or New Rock? Sirius has an array of choices spanning a vast range of musical tastes including the hits of the 50's, 60's, 70's, & 80's as well as Jazz, Country, Blues, Pop, Rap, R&B, Bluegrass, Alternative, Classical, Heavy Metal, Dance and many others...

From its state-of-the-art, digital broadcasting facility in Rockefeller Center, New York City, Sirius will deliver the broadest, deepest mix of radio entertainment from coast to coast.

Sirius will bring you music and entertainment programming that is simply not available on traditional radio in any market across the country. It's radio like you've never heard before.

So Get Sirius and Listen Up! For more information, visit siriusradio.com.

To receive Sirius Satellite on this receiver

This receiver contains a SIRIUS ID for user identification. All you have to do to obtain a subscriber contract and enable reception of Sirius Satellite is to call the Sirius Service Center (1-888-539-SIRIUS (7474), online at siriusradio.com) and inform us of your SIRIUS ID and a few other details.

Selecting Satellite mode

Press the [SAT] button to select the Satellite mode.

The Satellite indication lights entering the mode that was engaged when the unit was turned off last time.

Selecting a band

Press the [SAT] button to select a band.

Each press of the button changes the display as shown below.

SR1 → SR2 → SR3 → SR1 ...

- * The currently received band is displayed in the function mode indication.
- * Models without a function mode indication display the band name and channel number in the Operation status indication.

● Information displayed during reception

The following information is displayed in the Operation status indication when Sirius Satellite cannot be received normally.

- **UPDATING** : when the receiver is turned on the first time or after a reset.
- **ACQUIRING** : when a channel is being tuned in (no signal is yet received), or an antenna issue exists.
- **INVALID CH** : a channel without a broadcast has been selected, or the receiver may not be activated.
- **"CALL 888"** : a channel not covered by your contract.
→ **"539-SIRI"** Call Sirius Service Center (1-888-539-SIRIUS (7474)). Online at siriusradio.com
- **ANTENNA** : when the antenna is disconnected.
- **SUB UPDT** : when the subscription of a channel covered by your contract is being updated.

Switching the display

Each time you press the [DISP] button, the item changes as following order:

Channel name and band/channel number
 → **category name and band/channel number**
 → **title and artist name** → **radio text and band/channel number** → **clock display**
 → **channel name and band/channel number...**

Notes:

- The Operation status indication of the source unit displays the abbreviated channel name for 2 seconds when a station is selected before returning to the previous display mode.
- Scrolling starts when the channel name or other text has been displayed for 2 seconds. When scrolling finishes, the first text display appears. To start scrolling again, press and hold the [DISP] button for 1 second or longer.

Channel selection

Channels are selected with the following buttons.

- The [▲] or [▼] button
- The [DIRECT] buttons
- The [CAT] button

* For details, see the following operation descriptions.

Note:

- The audio output is muted and other button operations are not accepted during channel selection.

Tuning

There are 2 types of tuning modes available, seek tuning and preset tuning.

Seek tuning

Only channels that can be received are selected while channels without broadcasts and channels not covered by the contract are automatically skipped.

1. Press the [▲] or [▼] button. The receiver seeks the next available channel below or above the current channel.
2. Press and hold the [▲] or [▼] button. The receiver moves to seek channels below or above the current channel. If the channel found when either button is released is available that channel is received. Otherwise, seeking continues until an available channel is found.

Recalling a preset channel

A total of 18 SIRIUS channels can be stored (6-SR1, 6-SR2 and 6-SR3). This allows you to select your favorite SIRIUS channels and store them in memory for later recall.

1. Press the [SAT] button and select the desired SIRIUS band (SR1, SR2 or SR3).
2. To recall a stored SIRIUS channel, press the desired [DIRECT] button to select that channel.
 - * Press and hold one of the [DIRECT] buttons for 2 seconds or longer to store the current channel into preset memory.

Manual memory

1. Select the desired channel with seek tuning or preset tuning.
2. Press and hold one of the [DIRECT] buttons for 2 seconds or longer to store the current channel into preset memory.

Notes:

- When the name of a channel stored in memory is changed by a broadcasting channel, the display may show a channel name that differs from the stored name.
- A channel stored in memory may be discontinued at the option of the broadcasting channel.

Category selection function

Sirius Satellite allows you to select broadcast channel category (contents).

Receiving channels selected by category

This starts seek tuning and broadcast channels that meet the specified category are selected. The "CAT" indicator is displayed during the category selection mode.

1. Press the [CAT] button to enter the category selection mode.
2. Turn the [VOLUME] knob clockwise or counterclockwise to select a category. Or, press a [DIRECT] button if the category is preset.
 - * When 1 second has passed after selecting the category, UP SEEK is automatically performed, and a channel of the selected category is received. You can also perform seeking by using the [▲] or [▼] button.
3. Press the [CAT] button again to cancel.

Notes:

- When the category selection mode is entered, the category of the last received channel is displayed first.
- The category selection mode is canceled when no channel with the selected category can be found.
- Press the [▲] or [▼] button within 7 seconds after a channel has been set to continue seeking channels up or down. The category selection mode is canceled and normal reception is resumed if no operation is performed for 7 seconds.

Presetting a category

A category can be preset by registering specific categories in [DIRECT] buttons 1 to 6. Then the desired category can be recalled by pressing the corresponding [DIRECT] button.

1. Press the [CAT] button to enter the category mode.
2. Turn the [VOLUME] knob clockwise or counterclockwise to select a category.
3. Press and hold one of the [DIRECT] buttons for 2 seconds or longer to store the current category into preset memory.

Notes:

- When the name of a channel stored in memory is changed by a broadcasting channel, the display may show a channel name that differs from the stored name.
- A channel stored in memory may be discontinued at the option of the broadcasting channel.

Scan function

There are 2 scan modes: a category scan mode and a preset scan mode.

During scanning, channels are displayed in abbreviated form and the display mode cannot be switched.

● Category scan

In a category scan, broadcast channels in the same category as the current channel are selected about every 10 seconds.

1. Press the [ENT] button to start a category scan.
2. Press the [CAT] button, a [DIRECT] button, the [▲] or [▼] button to cancel a category scan.

Note:

- Category scanning is not available when no category is defined for the current channel.

● Preset scan

A preset scan scans the channels (up to 18 channels) stored in the preset memory about every 10 seconds.

1. Press and hold the [ENT] button for 2 seconds or longer to start a preset scan.
2. Press the [CAT] button, a [DIRECT] button, the [▲] or [▼] button to cancel a preset scan.

To verify your SIRIUS ID

For more information, see “Verifying your SIRIUS ID (Sirius mode only)” in “Common Operations”.

iPod Operations

Connecting the iPod CeNET Interface (additional EA1276B CeNET interface required) allows you to operate your iPod from the operation panel of this unit. This unit has the iPod MENU mode which allows you to operate by the same feeling as operating on the iPod.

In the iPod mode, this system considers all the tracks stored in the iPod as one album when selecting tracks or playing them back. To search tracks by the album title or the artist name by the similar operations from the Music menu of the iPod, see “**Selecting tracks in the iPod MENU mode**”.

Notes on using iPod

You can connect the following iPods:

- iPod G3 Ver. 2.3 or higher
- iPod G4 Ver. 3.1 or higher
- iPod Photo Ver. 1.2 or higher (Images cannot be displayed.)
- iPod mini Ver. 1.4 or higher
- iPod nano Ver. 1.0 or higher

Notes:

- iPod shuffle cannot be connected.
- When the iPod is connected, the operations on the iPod are prohibited.
- The characters that can be displayed are alphanumeric characters only. 2-byte characters cannot be displayed.

Selecting iPod mode

Press the [AUX] button to select the iPod mode.

Note:

- When “NO IPOD” is displayed, check whether the connectors of the iPod and iPod CeNET Controller are correctly connected.

Switching the display

Press the [DISP] button to select the desired display.

Each time you press the [DISP] button, the display switches in the following order:

Song name and Track number/Play time display

The song name, the current track number, and the play time are displayed.



Album/Artist display

The album title and artist name are displayed.



Clock Display

The current time is displayed.



Song name and Track number/Play time display

Note:

- Title characters which cannot be displayed by this unit are displayed with “*”.

Pausing play

1. Press and hold the [MUTE] button for 1 second or longer to pause playback. “PAUSE” appears on the display.
2. To resume playback, press and hold the [MUTE] button for 1 second or longer again.

Selecting a track

● Track-up

1. Press the [▲] button during playback to move ahead to the beginning of the next track.

● Track-down

1. Press the [▼] button during playback to move back to the beginning of the current track.
2. Press the [▼] button again within 2 seconds after the beginning of the track to move to the beginning of the previous track.

Fast-forward/fast-rewind

● Fast-forward

Press and hold the [▲] button for 1 second or longer during playback.

● Fast-rewind

Press and hold the [▼] button for 1 second or longer during playback.

Repeat play

This repeat playback of the track currently played back. It corresponds to the iPod operation of selecting “**Settings**” → “**Repeat (one)**” from the menu of the iPod.

1. Press the [REPEAT] button.
2. To cancel repeat playback, press the [REPEAT] button again.

All repeat play

This repeat playback of the all tracks. It corresponds to the iPod operation of selecting “**Settings**” → “**Repeat (ALL)**” from the menu of the iPod.

1. Press and hold the [REPEAT] button for 1 second or longer.
2. To cancel All repeat playback, press the [REPEAT] button again.

Random play

This specifies random playback of the tracks included in the album. It corresponds to the iPod operation of selecting “**Settings**” → “**Shuffle (Albums)**” from the menu of the iPod.

1. Press the [RANDOM] button.
2. To cancel random playback, press the [RANDOM] button again.

All random play

This specifies random playback of all the tracks. It corresponds to the iPod operation of selecting “**Settings**” → “**Shuffle (Songs)**” from the menu of the iPod.

1. Press and hold the [RANDOM] button for 1 second or longer.
2. To cancel the All random playback, press the [RANDOM] button again.

Selecting tracks in the iPod MENU mode

In the iPod mode, you can select tracks by the album title or artist name by the similar operations on the iPod as well as the iPod Music menu.

Note:

- In the iPod MENU mode, you cannot specify the fast-forward, fast-backward, repeat and random playback.

1. Press the [CAT] button.
 - * The “CAT” indicator is lit when the system enters in the iPod MENU mode. Press the [CAT] button again to return to the iPod mode.
2. Turn the [VOLUME] knob to select the menu, then press the [▼] button. Or, press either of the [DIRECT] (1 to 6) button.
 - [DIRECT] (1) “PLAYLISTS”
 - [DIRECT] (2) “ARTISTS”
 - [DIRECT] (3) “ALBUMS”
 - [DIRECT] (4) “SONGS”
 - [DIRECT] (5) “GENRES”
 - [DIRECT] (6) “COMPOSERS”
3. Turn the [VOLUME] knob to select the menu, then press the [▼] button. Select tracks by repeating this operation.

Notes:

- The number of repeating operation is differ depending to the selected menu.
- To return to the previous list, press the [▲] button. However, you cannot return to the menu of the step 2. Perform the operation from the step 1 again.

CD Changer Operations

CD changer functions

When an optional CD changer (additional DCZ625 CeNET changer required) is connected through the CeNET cable, this unit controls all CD changer functions. This unit can control a total of 2 changers.

Press the [DISC] button to select the CD changer mode to start play. If 2 CD changers are connected, press the [DISC] button to select the CD changer for play.

- * If “**NO MAG**” appears on the display, insert the magazine into the CD changer. “**D-CHECK**” appears on the display while the player loads (checks) the magazine.
- * If “**NO DISC**” appears on the display, eject the magazine and insert discs into each slot. Then, reinsert the magazine back into the CD changer.

Note:

- Some CDs recorded in CD-R/CD-RW mode may not be usable.

▲ CAUTION

Depending on the recording format, CD-ROM discs may not play properly.

Pausing play

1. Press and hold the [MUTE] button for 1 second or longer to pause play. “**PAUSE**” appears on the display.
2. To resume CD play, press and hold the [MUTE] button for 1 second or longer again.

Selecting a track

● Track-up

1. Press the [▲] button to move ahead to the beginning of the next track.
2. Each time you press the [▲] button, the track advances ahead to the beginning of the next track.

● Track-down

1. Press the [▼] button to move back to the beginning of the current track.
2. Press the [▼] button twice to move to the beginning of the previous track.

Fast-forward/fast-rewind

● Fast-forward

Press and hold the [▲] button for 1 second or longer.

● Fast-rewind

Press and hold the [▼] button for 1 second or longer.

Selecting a CD

1. Press the [←DISC→] button to select the desired disc.
 - * If a CD is not loaded in a slot of magazine, pressing the [←DISC→] button can not work.

Scan play

Scan play locates and plays the first 10 seconds of each track on a disc automatically. This function continues on the disc until it is canceled.

- * The scan play is useful when you want to select a desired track.
1. Press the [SCAN] button.
 2. To cancel the scan play, press the [SCAN] button again.

Disc scan play

Disc scan play locates and plays the first 10 seconds of the first track on each disc in the currently selected CD changer. This function continues automatically until it is canceled.

- * Disc scan play is useful when you want to select a desired CD.
1. Press and hold the [SCAN] button for 1 second or longer.
 2. To cancel disc scan play, press the [SCAN] button again.

Repeat play

Repeat play continuously plays the current track. This function continues automatically until it is canceled.

1. Press the [REPEAT] button.
2. To cancel repeat play, press the [REPEAT] button again.

Disc repeat play

After all the tracks on the current disc have been played, disc repeat play automatically replays the current disc over from the first track. This function continues automatically until it is canceled.

1. Press and hold the [REPEAT] button for 1 second or longer.
2. To cancel disc repeat play, press the [REPEAT] button again.

Random play

Random play selects and plays individual tracks on the disc in no particular order. This function continues automatically until it is canceled.

1. Press the [**RANDOM**] button.
2. To cancel random play, press the [**RANDOM**] button again.

Disc random play

The disc random play selects and plays individual tracks or discs automatically in no particular order. This function continues automatically until it is canceled.

1. Press and hold the [**RANDOM**] button for 1 second or longer.
2. To cancel disc random play, press the [**RANDOM**] button again.

TV Operations

TV tuner functions

When an optional TV tuner (additional TTX7501Z CeNET module required) is connected through the CeNET cable, this unit controls all TV tuner functions. To watch TV requires a TV tuner and monitor.

Watching a TV

1. Press the [AM/FM] button and select the TV mode.
2. Press the [AM/FM] button to select the desired TV band (TV1 or TV2). Each time the button is pressed, the input selection toggles between TV1 and TV2.
3. Press the [▲] or [▼] button to tune in the desired TV station.

Tuning

There are 3 types of tuning modes available, seek tuning, manual tuning and preset tuning.

Seek tuning

1. Press the [AM/FM] button and select the desired TV band (TV1 or TV2).
 - * If "MANU" is lit on the display, press and hold the [AM/FM] button for 1 second or longer. "MANU" on the display goes off, and seek tuning is now available.
2. Press the [▲] or [▼] button to automatically seek a station. Press the [▲] button to automatically tune up the frequency band to the next available TV station; press the [▼] button to automatically tune down.

Manual tuning

There are 2 manual tuning methods available: Quick tuning and step tuning.

When you are in the step tuning mode, the frequency changes one step at a time. In the quick tuning mode, you can quickly tune the desired frequency.

1. Press the [AM/FM] button and select the desired band (TV1 or TV2).
 - * If "MANU" is not lit on the display, press and hold the [AM/FM] button for 1 second or longer. "MANU" lights on the display and manual tuning is now available.
2. Tune in a station.

● Quick tuning

Press and hold the [▲] or [▼] button for 1 second or longer to tune in a station.

● Step tuning

Press the [▲] or [▼] button to manually tune in a station.

Recalling a preset station

A total of 12 TV stations can be stored (6-TV1 and 6-TV2). This allows you to select your favorite TV stations and store them in memory for later recall.

1. Press the [AM/FM] button and select the desired TV band (TV1 or TV2).
2. To recall a stored TV station, press the desired [DIRECT] button.
 - * Press and hold one of the [DIRECT] buttons for 2 seconds or longer to store the current station into preset memory.

Manual memory

1. Select the desired station with seek tuning, manual tuning or preset tuning.
2. Press and hold one of the [DIRECT] buttons for 2 seconds or longer to store the current station into preset memory.

Auto store

Auto store selects 6 TV stations automatically and stores each one into preset memory.

If there are not 6 stations with good reception, stations previously stored in memory remain and only the strong stations are stored into memory.

1. Press the [AM/FM] button and select the desired TV band (TV1 or TV2).
2. Press and hold the [ENT] button for 2 seconds or longer. The stations with good reception are stored automatically to the preset channels.

Preset scan

Preset scan allows the user to view each preset position before it automatically advances to the next preset. This function is useful for searching for a desired TV station in memory.

1. Press the [ENT] button.
2. When the desired station is found, press the [ENT] button again to remain tuned to that station.

Note:

- Do not press and hold the [ENT] button for 2 seconds or longer. Doing so will trigger the auto store function and start storing stations into memory.

Setting TV/VTR and TV diver

To switch TV to VTR, to select the TV area, and to set the TV diver, see "Common Operations".

6. TROUBLESHOOTING

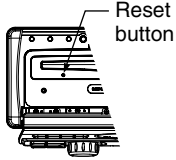
	Problem	Cause	Measure
General	Power does not turn on. (No sound is produced.)	Fuse is blown.	Replace with a fuse of the same amperage. If the fuse blows again, consult your store of purchase.
		Incorrect wiring.	Consult your store of purchase.
	No sound output when operating the unit with amplifiers.	Amplifier turn-on lead is shorted to ground or excessive current is required.	Turn the unit off and check each wire for a possible short. If the amplifier turn-on lead shorts out, cover it with insulation such as tape.
	Nothing happens when buttons are pressed.	The microprocessor has malfunctioned due to noise, etc.	<p>Open the front panel by pressing the [OPEN] button. Press the reset button for about 2 seconds with a thin rod.</p> <p>The settings will remain in the ROM even if you press the reset button.</p> 
	No audio.	The speaker protection circuit is operating.	<ol style="list-style-type: none"> 1. Check the speaker connection. 2. Turn down sound volume. Function can also be restored by turning the power off and on again. 3. If the sound is muted again, consult your store of purchase.
	The settings in the ROM are not stored properly.	ROM failure.	If the error persists, consult your store of purchase.
CD/MP3/WMA	Disc does not start.	The unit is not turned on.	Turn the power on.
	No sound heard.	There is a disc other than a compact disc or foreign matter already in place.	Press the [▲] button to eject.
		MP3/WMA files are absent in a disc.	Write MP3/WMA files onto the disc properly.
		Files are not recognized as an MP3/WMA file.	Use MP3/WMA files encoded properly.
		File system is not correct.	Use ISO9660 level 1, 2 or JOLIET or Romeo file system.
	Sound skips or is noisy.	Disc is dirty.	Clean the disc with a soft cloth.
Disc is heavily scratched or warped.		Replace with a disc with no scratches.	

	Problem	Cause	Measure
CD/MP3/WMA	Sound is cutting out or skipping. Noise is generated or noise is mixed with sound.	MP3/WMA files are not encoded properly.	Use MP3/WMA files encoded properly.
	Sound is bad directly after power is turned on.	Water droplets may form on the internal lens in a humid place.	Let dry for about 1 hour with the power on.
	Wrong filename.	File system is not correct.	Use ISO9660 level 1, 2 or JOLIET or Romeo file system.
CeNET	Source selection does not recognize CeNET source connection.	The microprocessor has not stored the proper CeNET information.	Perform a system check. See " Common Operations ", performing a system check section.
		The CeNET cable is not connected properly.	Ensure the CeNET cables are properly connected.

7. ERROR DISPLAYS

If an error occurs, one of the following displays is displayed.
Take the measures described below to eliminate the problem.

	Error Display	Cause	Measure
CD/MP3/WMA	ERROR 2	A DISC is caught inside the CD deck and is not ejected.	This is a failure of CD deck's mechanism and consult your store of purchase.
	ERROR 3	A DISC cannot be played due to scratches, etc.	Replace with a non-scratched, non-warped-disc.
	ERROR 6	A DISC is loaded upside-down inside the CD deck and does not play.	Eject the disc then reload it properly.
iPod	NO IPOD	A communication error occurs between the iPod and the iPod CeNET Controller.	Disconnect the iPod, then connect it again.
CD changer	ERROR 2	A CD inside the CD changer is not loaded.	This is a failure of CD changer's mechanism. Consult your store of purchase.
	ERROR 3	A CD inside the CD changer cannot be played due to scratches, etc.	Replace with a non-scratched, non-warped disc.
	ERROR 6	A CD inside the CD changer cannot be played because it is loaded upside-down.	Eject the disc, then reload it properly.
General	AMP GRD	The speaker protection circuit is operating. During this operation, if any volume operation is performed, the display shows " AMP GUARD ". " AMP GUARD " sometimes functions when special test signals are used.	<ol style="list-style-type: none"> 1. Turn down sound volume. Function can also be restored by turning the power off and on again. (Speaker volume is reduced automatically when the speaker protection circuit operates.) 2. If the sound is muted again, consult our service department.

If an error display other than the ones described above appears, press the reset button. If the problem persists, turn off the power and consult your store of purchase.

8. SPECIFICATIONS

Source unit harness wire connections

Wire Color	Function
Yellow	+12 V DC Constant Power Source/Memory
Red	+12 V DC Switch Lead/Accessory
Black	Ground
Blue/White	Amplifier Remote Turn-on
Grey	Right Front Speaker (+)
Grey/Black	Right Front Speaker (-)
White	Left Front Speaker (+)
White/Black	Left Front Speaker (-)
Purple	Right Rear Speaker (+)
Purple/Black	Right Rear Speaker (-)
Green	Left Rear Speaker (+)
Green/Black	Left Rear Speaker (-)
Brown	Phone Mute

RCA Connections

Wire Color	Function
Grey/Red	Right Front Line Level Output (Full range)
Grey/White	Left Front Line Level Output (Full range)
Black/Red	Right Rear Line Level Output (Full range)
Black/White	Left Rear Line Level Output (Full range)
Purple/Red	Right Non-Fade Line Level Output (Full range)
Purple/White	Left Non-Fade Line Level Output (Full range)
Red/Red	Right Auxiliary Input
Red/White	Left Auxiliary Input

FM Tuner

Frequency Range:

U.S.A: 87.9 MHz to 107.9 MHz

Europe: 87.5 MHz to 108.0 MHz

Australia: 87.0 MHz to 108.0 MHz

Usable Sensitivity: 9 dBf

50 dB Quieting Sensitivity: 15 dBf

Alternate Channel Selectivity: 70 dB

Stereo Separation (1 kHz): 35 dB

Frequency Response (± 3 dB): 30 Hz to 15 kHz

AM Tuner

Frequency Range:

U.S.A: 530 kHz to 1710 kHz

Europe: 531 kHz to 1602 kHz

Australia: 531 kHz to 1629 kHz

Usable Sensitivity: 25 μ V

CD Player

System: Compact disc digital audio system

Usable Discs: Compact disc

Frequency Response (± 1 dB): 10 Hz to 20 kHz

Signal to Noise Ratio (1 kHz): 100 dB

Dynamic Range (1 kHz): 95 dB

Harmonic Distortion: 0.02%

Audio

Maximum Power Output: 200 W (50 W \times 4 ch)

Bass Control Action (60 Hz): ± 14 dB

Treble Control Action (10 kHz): ± 14 dB

Line Output Level (CD 1 kHz): 2 V

General

Power Supply Voltage:

14.4 V DC (10.8 to 15.6 V allowable),
negative ground

Current Consumption: Less than 15 A

Speaker Impedance: 4 Ω (4 Ω to 8 Ω allowable)

Weight / Source unit: 4.62 lb. (2.1 kg)

Weight / Remote control unit:

1.41 oz. (40 g) (including battery)

Dimensions / Source unit:

7-1/8" (Width) \times 2" (Height) \times 7-7/10" (Depth)
[180.4 (W) \times 51.2 (H) \times 195.5 (D) mm]

Dimensions / Remote control unit:

1-3/4" (Width) \times 4-7/16" (Height) \times 1/2"
(Depth) [44 (W) \times 113 (H) \times 13 (D) mm]

Escutcheon section:

7-7/8" (Width) \times 3-5/8" (Height) \times 1-7/8"
(Depth) [199.4 (W) \times 91.9 (H) \times 47 (D) mm]

Power Output:

21 W RMS \times 4 Channels at 4 Ω
and 1% THD+N

Signal to Noise Ratio:

91 dBA (reference: 1 W into 4 Ω)



Note:

- Specifications and design are subject to change without notice for further improvement.

Clarion

Clarion ■

// High-Tech High-Touch //

» DICHIARAZIONE DI CONFORMITA' «
(D.M. 28 agosto 1995, no548)

Io, Fabbricante / Mandatario nell'UE

**Clarion Europa GmbH
Hessenring 19-21
64546 Mörfelden-Walldorf**

Dichiaro che il prodotto

**AM/FM Ricevente di suono radiodiffusione con CD
CMD5**

**è conforme alle disposizioni contenute nel suddetto
decreto relativamente alla prevenzione e l'eliminazione
dei disturbi radioelettrici provocati dai ricevitori di
radiodiffusione sonora e televisiva.**

Io, Fabbricante / Mandatario nell'UE

Data 12 Dicembre 2006

**Clarion Europa GmbH
Hessenring 19-21
64546 Mörfelden-Walldorf**

Firma



PBL No 06IRDC001J

IDCRNTPNLH02C

Clarion

TEL :+49-6105-977-0
FAX :+49-6105-977-399



CE DECLARATION OF CONFORMITY

We, Clarion Europa GmbH

(supplier's name)

Hessenring 19-21, 64546 Mörfelden-Walldorf, GERMANY
(address)

declare under our sole responsibility that the product

AM/FM Broadcast Receiver with CD Player:

MODEL: CMD5

Product code: PE2930

(name, type or model, possibly sources and numbers of items)

to which this declaration relates is in conformity with the following
standard(s) or other normative document(s)

EN 55013:2001 + A1, EN 55020:2002 + A1

(title and/or number and date of issue of the standard(s) or
other normative document(s))

(if applicable) following the provisions of 89/336/EEC Directive.

Product Family

Basic Model and Name: AM/FM Car Radio with CD Player

Difference: Trim and Use for only Recreational Craft;

(supplier's comment)

Mörfelden-Walldorf, GERMANY

Susumu Yamakawa

12 DEC. 2006

President

(Place and date of issue)

(name and signature or equivalent
marking of authorized person)

RefNo 06MRDC001 *D.F.DQC06A184*



TEL +49-6105-977-0
FAX +49-6105-977-399

Clarion Co., Ltd.

All Rights Reserved. Copyright © 2007: Clarion Co., Ltd.
Printed in Philippines / Imprimé aux Philippines /
Impreso en Filipinas / Stampato nelle Filippine

PE-2930B
PE-2930E
280-8477-00