

# OWNER'S MANUAL

Dear Boat Owner:

READ THIS MANUAL THOROUGHLY BEFORE FIRST USE OF YOUR BOAT. REVIEW IT PERIODICALLY. IT CONTAINS USEFUL INFORMATION AND IMPORTANT PRECAUTIONS TO OBSERVE.

Sincerely,

Correct Craft, Inc.

# ● TABLE OF CONTENTS:

1. PREFACE
2. NOTICE TO OWNER
3. CAUTIONS & WARNING LABELS
4. GENERAL INBOARD OPERATIONS AND MAINTENANCE
5. CAPACITY PLATE
6. HULL IDENTIFICATION NUMBER
7. COMMON SENSE BOATING
8. COSMETIC CARE
9. YOUR BOAT
10. TRAILER

10 9 8 7 6 5 4 3 2 1

## NAUTIQUE FRIEND PROGRAM

It has been proven that experience and word-of-mouth are important promotional tools. Enthusiastic boat owners talk to their friends. Friends buy boats. Our statistics reveal that a high percentage of our Nautique owners learned about Correct Craft through a friend. We want to show our appreciation to that friend, and have chosen the following methods of doing so.

- One year after the purchase date listed on an owner's warranty card, we send a "NEW OWNER SATISFACTION SURVEY". For the completion and return of this form, we offer a first anniversary gift of a Fashion Nautique T-shirt. It is our desire to keep in touch with our Correct Craft family of boat owners. We value our owners' comments and want to hear about the things we do right and/or the things we need to improve. One of the questions asked is, "How did you learn of Correct Craft?" This section adds a statement, "if a friend influenced you, please list his/her name and address." From this information, the President of Correct Craft sends that "Friend" a letter of thanks and a Fashion Nautique cap. So proud are we of this contact that we keep a running list of all those in this category.
- When a "Friend" appears on our list the second time, indicating success in encouraging yet another person to purchase a Nautique, this person receives a personal thank you letter from the President of Correct Craft with a certificate to return with the appropriate size indicated, and receive a Correct Craft T-shirt.
- When a "Friend's" name is presented for the third time, again this person will receive a personal letter from the President of Correct Craft with a certificate to return with the appropriate size indicated, and receive a Correct Craft polo shirt.
- For the fourth and succeeding times a "Friend" is listed, a personal letter will be mailed as well as a certificate for \$50 retail value of Fashion Nautique item(s).

Tell the story of your experiences with your boat, your dealer, and Correct Craft. When you are responsible for convincing a non-Correct Craft owner to buy a Nautique, encourage that new owner to give you credit for that introduction on his first anniversary survey form.

## PREFACE

*Dear Correct Craft Owner:*

*Congratulations on your purchase of a Correct Craft boat. You have chosen a craft that is unexcelled "on the waters of the world."*

*Since 1925, we have manufactured only the finest products the boat builders art can produce, even extending, by the grace of God, to stunning achievements in the making of boats serving in defense of our country.*

*Your Correct Craft was manufactured with the latest skills in marine technology and materials, however, something very special was added along the way -- a legacy handed down by W. C. Meloon over 60 years ago. His dedication to building boats to the glory of God remains true today as the cornerstone of our commitment in bringing to you the finest in pleasure boating. We ask that you take the time to review all of the data that has been assembled in your owner's manual. You will find many useful hints on care and maintenance, as well as some cautions that apply to your boat.*

*Many years of boat building experience have gone into the production of your boat. We hope that you will enjoy it to the fullest. Welcome "on the waters of the world."*

*Sincerely,*



*Walter N. Meloon  
President/Chief Executive Officer*

*Yours, O Lord, is the  
Greatness and the Power  
and the Glory and the Majesty  
and the Splendor,  
for everything in heaven  
and Earth is Yours.  
You are Before all Things,  
and in You all  
Things hold together.*

*1 Chronicles 29, Colossians 2*

## PREFACE, CONT.

If you find that the information contained in this owner's manual does not answer your specific question, then we invite you to contact your nearest dealer or your Correct Craft regional warehouse for answers or necessary service. A list of the Correct Craft warehouses is given below, with the specific areas that they service.

**Mid Atlantic Correct Craft**  
Route 30 Box 188  
Speculator, NY 12164  
(518) 548-9763

Maryland  
New Jersey  
New York  
Pennsylvania (Eastern)  
Virginia  
Delaware  
District of Columbia

**MID-WEST CORRECT CRAFT**

P. O. Box 216  
Angola, IN 46703  
260/833-2226

Illinois  
Indiana  
Iowa  
Kentucky  
Michigan  
Minnesota  
Missouri  
Nebraska  
North Dakota  
Ohio  
Pennsylvania (Western)  
South Dakota  
West Virginia  
Wisconsin

**SOUTHWEST CORRECT CRAFT**

22450 FM RD 1995  
Lindale, TX 75771  
903/882-8593

Arkansas  
Kansas  
Louisiana  
Oklahoma  
Texas

Connecticut  
Maine  
Massachusetts  
New Hampshire  
Rhode Island  
Vermont

**SOUTHEAST CORRECT CRAFT**

7576 South Orange Avenue  
Orlando, Florida 32809  
407/851-1965

Alabama  
Florida  
Georgia  
Mississippi  
North Carolina  
South Carolina  
Tennessee

**WEST COAST CORRECT CRAFT**

3160 GOLD VALLEY DR, STE 500  
RANCHO CORDOVA, CA 95742  
916/638-3382

Alaska  
Arizona  
California  
Colorado  
Hawaii  
Idaho  
Montana  
Nevada  
New Mexico  
Oregon  
Utah  
Washington  
Wyoming

If, for any reason your nearest dealer or the warehouse servicing your territory cannot satisfactorily resolve your problem or answer your questions, then please feel free to contact our Customer Service Department at the main offices of Correct Craft, Inc., either by telephone or by mail.

**CORRECT CRAFT, INC.**  
6100 South Orange Avenue  
Orlando, FL 32809  
407/855-4141

THANK YOU AND ENJOY YOUR CORRECT CRAFT!

**TO THE ATTENTION OF THE SECOND OWNER:**

Some Ski Nautiques, Sport Nautiques and Nautique Super Sports can be outfitted with a customized dash plaque. As a second owner, you may have the option of having a plaque made for your boat which reads:

Performance engineered for: (your name).

If you would like a customized dash plaque and you own a boat which is designed for such, complete and mail this form along with \$10 payable to Correct Craft, attention Victoria Zacktan, and we will be happy to provide you with this replacement plaque.

REQUEST FOR REPLACEMENT PERSONALIZED DASH PLAQUE

NAME ON PLAQUE: \_\_\_\_\_

My boat is a \_\_\_SKI NAUTIQUE, \_\_\_SPORT NAUTIQUE, \_\_\_NAUTIQUE SUPER SPORT

Hull Number: \_\_\_\_\_

Mail to: \_\_\_\_\_

Address: \_\_\_\_\_

City/State/Zip: \_\_\_\_\_

Signature \_\_\_\_\_

Date \_\_\_\_\_

Send form and \$10 to: Correct Craft, ATTN: Victoria Zacktan, 6100 S. Orange Avenue, Orlando, FL 32809.

## NOTICE TO OWNER

We realize that you, as the owner of a new boat, are anxious to get it in the water and go. That is understandable. However, you have a valuable investment to protect, so we suggest that you hold your enthusiasm in check and take the time to read this manual first. You will be a lot more comfortable when you take to the water.

**ENJOY YOUR CORRECT CRAFT:** Generally, preparation services are part of your agreement with your dealer and all of the following should have been completed. However, it is your responsibility to check to see that each and every preparation step listed below has been completed by your dealer or yourself before you use your boat. Be sure that these preparations have been accomplished.

If, as is true in most instances, the prep work has been completed, it's still a good idea to review this "notice."

In addition to any dealer preparation, it is every owner's obligation to periodically check these items. If leaks or abnormalities are found, stop, shut off engine and do not operate until your local dealer has corrected the problem(s). You will be more familiar with your craft and, thus, more confident.

### TO DEALER:

THIS BOAT HAS BEEN WATER TESTED BEFORE LEAVING THE FACTORY. HOWEVER, BEFORE DELIVERY TO CONSUMER, YOU MUST MAKE THE FOLLOWING INSPECTIONS AND ADJUSTMENTS. THE CORRECT CRAFT FACTORY WINTERIZED THIS BOAT, SO CHECK ALL WATER CONNECTIONS (REGARDLESS OF SEASON).

1. Open motor cover then **LEAVE OPEN** while starting and checking engine.
2. All engine drain plugs should be in. Replace any hose that is off the engine (refer to engine manual).
3. **VERY IMPORTANT!** Check all gasoline line connections. Fill gasoline tank. (All Correct Craft boats since 1972 are equipped with an anti-siphon valve.) Check for leaks after filling with gasoline and again after the engine has run for a few minutes.
4. **IMPORTANT!** Check engine oil level and transmission oil level.
5. Battery must be 12 volt (neg. ground), and of proper rating and physical size as indicated in the engine manual. (There is a sticker affixed to the battery box lid that will give you this information.)
6. Check all wiring for loose connections.

## **NOTICE TO OWNER**

7. Install propeller on shaft, taking care that key fits properly, nut pulls prop up tight on shaft taper, and cotter pin is in place properly. Check engine alignment.
8. Install hull drain plug. (Sport Nautiques are equipped with two drain plugs.)
9. Now, if your boat is not yet in the water, you should launch it at this time.
10. Make sure motor cover is open and run blower at least four minutes before starting engine. Turn the blower on with the dash switch.
11. Start engine, being extremely careful not to become entangled in the belts and pulleys, as personal injury may result. Visually check the following:

Oil pressure gauge for proper reading (see engine owner's manual).

Cooling water circulation (observe water filter).

Cooling water temperature gauge for proper reading (see engine owner's manual).

Charging system voltmeter for proper reading (see engine owner's manual).

Check for gasoline and cooling water leaks.

### **CAUTION! NEVER RUN ENGINE WITHOUT COOLING WATER.**

12. Water test boat, observing engine manufacturer's suggested break-in procedure.
13. Check again for fuel system leaks throughout the entire system.
14. Visually check for water leakage at propeller shaft stuffing box and adjust if necessary. (Refer to "Propeller Shaft Stuffing Box" in the Operational Maintenance section of the owner's manual for more details on adjusting the stuffing box.)

**2**



## **NOTICE TO OWNER**

15. To protect your investment we suggest that you return your boat to your local dealer after 25 hours of operation and have the engine alignment re-checked, have the stuffing boxes checked for proper adjustment and have the fuel system checked for leaks. Follow engine manufacturer's recommendations for additional service (see engine owner's manual). This is not a free service. Consult you dealer to ascertain what charges will apply.

**NOTE:** Read the "Notice to Dealer" sticker which is affixed to the inside of your motor box. Remember, these preparation checks have probably already been made by your dealer, but it is the owner's obligation to check these items. You will be more familiar with your craft.

We suggest that you now read "OPERATIONAL MAINTENANCE" to further familiarize yourself with your boat.

THE FOLLOWING PRECAUTIONS ARE **VITALLY** IMPORTANT TO YOUR PERSONAL WELL-BEING AND THAT OF YOUR BOAT.

**FUEL:** NEVER USE ANY FUEL OTHER THAN GASOLINE IN YOUR BOAT. ALCOHOL BLENDED FUELS MAY CAUSE DETERIORATION OF THE FUEL SYSTEM COMPONENTS. THIS MAY LEAD TO POTENTIALLY DANGEROUS CONDITIONS, INCLUDING FIRE AND POSSIBLE EXPLOSION.

**REPLACEMENT PARTS:** UNDER NO CIRCUMSTANCES SHOULD YOU USE NON-MARINE APPROVED REPLACEMENT PARTS. A MARINE ENGINE IS DESIGNED FOR MARINE USE. IF YOU NEED A REPLACEMENT PART, CONTACT YOUR DEALER, AN INBOARD BOAT MECHANIC OR CORRECT CRAFT, INC.

**AGAIN, NEVER USE AUTOMOTIVE PARTS ON A MARINE ENGINE. USE ONLY MARINE APPROVED PARTS.**

WE URGE YOU TO FOLLOW THESE PRECAUTIONS CAREFULLY, FOR OPTIMUM ENJOYMENT OF YOUR CORRECT CRAFT.

## CAUTION AND WARNING LABELS

The following are samples of the warning/information labels that should be affixed to your boat and trailer. It is your responsibility to maintain the legibility of these labels and to heed their warnings.

Be sure that all of the warning/information labels on your boat are legible and not marred. If your warning labels are not intact and readable, please contact Correct Craft for a replacement set. These labels serve a vital function of warning you and your passengers and must remain in good condition on your boat. NOTE: the warning/information label is listed next to each below.

BATTERY INFORMATION				
ENGINE SIZE	COLD CRANK	RESERVE CAPACITY (MN)	BATTERY TYPE (BCI)	BATTERY SIZE
305-302 350-351	380A	115	43 MARINE	13"L, 8"H 6¾"W
454-460	465A	125	24 MARINE	11"L, 9½"H 6¾"W

WITH TAPERED POST CONNECTORS

Battery Box

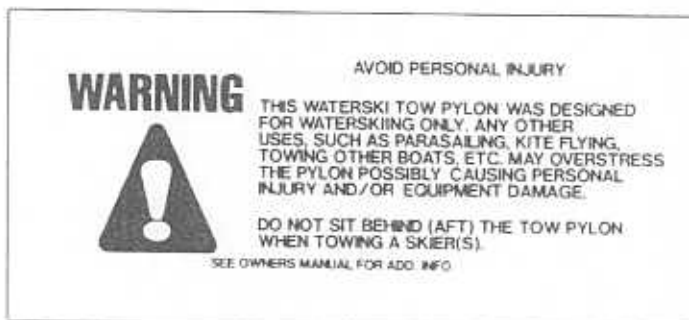

Tow Pylon

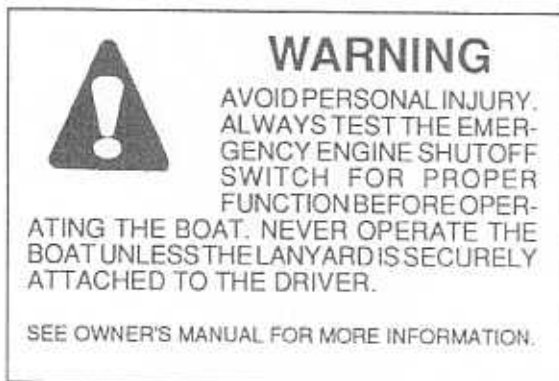

Emergency Shut-off Switch

## CAUTION AND WARNING LABELS



Dash

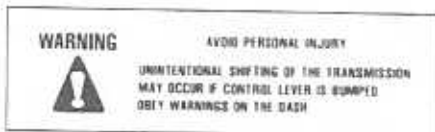

Throttle Control

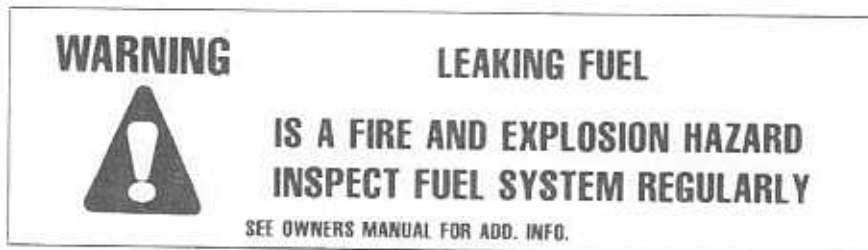

Inside Motor Box  
& On Fuel Tank

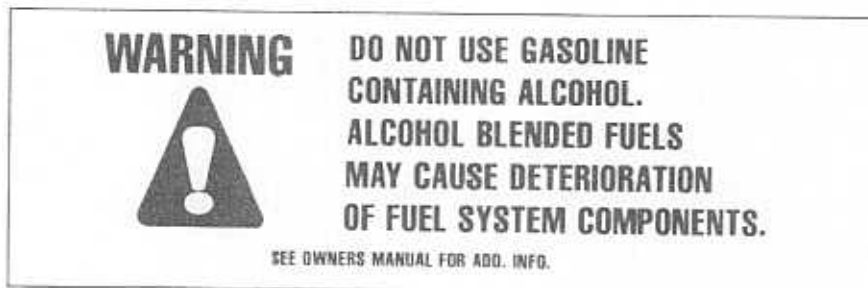

Fuel Fill

3

CAUTION AND WARNING LABELS

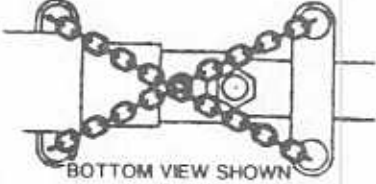

Dash

<p><b>WARNING</b></p> 	<p><b>AVOID PERSONAL INJURY AND EQUIPMENT DAMAGE NEVER PLACE HANDS OR OTHER BODY PARTS BETWEEN THE COUPLING AND ANY PART OF THE TOW VEHICLE .</b></p> <p><b>ALSO BEFORE TRAILING :</b></p> <p>(1) HITCH ONLY TO BALL SIZE MARKED ON COUPLING. (2) BE CERTAIN HITCH BALL IS FULLY ENGAGED IN COUPLER AND LOCKING LEVER IS DOWN. (3) CROSS SAFETY CHAINS UNDER COUPLING. (4) ALLOW ONLY ENOUGH SLACK IN SAFETY CHAINS FOR TURNS.</p>	 <p>BOTTOM VIEW SHOWN</p>
---	--	--

Trailer Tongue

<p><b>CAUTION</b></p> 	<p>TO AVOID EQUIPMENT DAMAGE, NEVER TOW YOUR BOAT AND TRAILER UNLESS TURNBUCKLE IS ATTACHED TO BOTH. DRIVE BOAT ON TRAILER, ATTACH TURNBUCKLE TO BOAT AND TRAILER BEFORE PULLING FROM WATER. DO NOT TIGHTEN TURNBUCKLE UNTIL THE BOAT IS CLEAR OF THE WATER.</p>
---	--

Trailer Tongue



## CAUTION AND WARNING LABELS

### CAUTION



TO AVOID EQUIPMENT DAMAGE, NEVER TOW YOUR BOAT AND TRAILER UNLESS THE TURNBUCKLE IS ATTACHED TO BOTH AND THE WINCH IS IN THE LOCKED POSITION.

Winch Stand

### WARNING



#### AVOID PERSONAL INJURY

THIS WATER SKI TRANSOM TOW RING WAS DESIGNED FOR WATER SKIING ONLY. ANY OTHER USES, SUCH AS PARASAILING, KITE FLYING, TOWING OTHER BOATS, ETC. MAY OVERSTRESS THE TRANSOM TOW RING, POSSIBLY CAUSING PERSONAL INJURY AND/OR EQUIPMENT DAMAGE.

DO NOT TOW MORE THAN TWO WATER SKIERS WITH THIS TRANSOM TOW RING.

Transom

### CAUTION



AVOID EQUIPMENT DAMAGE. TRAILER WHEEL LUG NUTS SHOULD BE TIGHTENED TO 90-95 FT. LBS. CHECK WHEEL LUG NUT TIGHTNESS BEFORE EVERY USE.

Trailer Tongue



CAUTION

AVOID EQUIPMENT DAMAGE ! DO NOT LOSE SEAL RING WHEN CLEANING WATER STRAINER ELEMENT AND CANISTER. IF IT IS LOST DO NOT OPERATE ENGINE UNTIL THE SEAL RING IS REPLACED.

Water Strainer

3

CAUTION AND WARNING LABELS

**WARNING**



AVOID PERSONAL INJURY. TRAILER SURFACES ARE SLIPPERY WHEN WET. USE EXTREME CARE WHEN STEPPING ON THEM.

Trailer Fenders



**CAUTION**

**AVOID EQUIPMENT DAMAGE AND PERSONAL INJURY CAUSED BY LOSS OF VEHICLE CONTROL. DO NOT TOW TWO TRAILERS BEHIND YOUR TOW VEHICLE!**

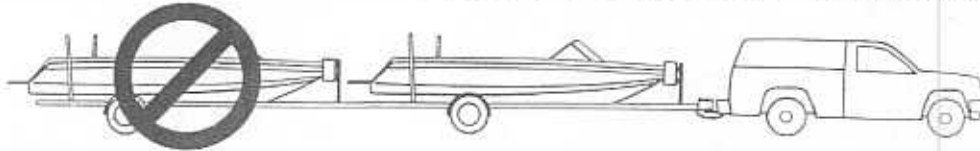

**3**

## OPERATIONAL MAINTENANCE

**CARE OF YOUR BOAT:** As with a car, the old adage "*An ounce of prevention is worth a pound of cure*" applies to your boat. Whether it be engine, finish or upholstery, the key word is "prevention." Here are some tips that will help keep your boat in good running order and in good condition.

The first thing you should consider is the OPERATIONAL MAINTENANCE of your boat.

1. Read the instructions in your engine manual very carefully.
2. Keep a daily look-out for fuel line leaks.
3. **NEVER** start your engine if gasoline odor is present. Gasoline fumes are highly explosive, so before starting your engine, open your engine cover, inspect the engine compartment for gasoline fumes and operate the blower for at least four minutes. Run your blower when operating at slow speeds.
4. When servicing the ignition or wiring, always disconnect battery cables at the battery terminals.
5. Check for water circulation. Exhaust should contain steady flow of water. In closed cooling systems, have water at the proper level. (Check your engine manual.)

**ALL CORRECT CRAFT BOATS ARE PROVIDED WITH A ROD OR ELECTRIC ACTUATOR THAT WILL HOLD THE ENGINE COVER IN AN OPEN POSITION. THE ROD VERSION SWIVELS FROM THE FLOOR OF THE BOAT AND SHOULD BE ENGAGED IN ITS RECEPTACLE MOUNTED INSIDE THE ENGINE COVER. FAILURE TO DO THIS MAY CAUSE EQUIPMENT DAMAGE OR RESULT IN INJURY.**

**SPARK PLUGS:** Check spark plugs every 100 hours and refer to your engine manual. Replace them if they appear pitted or burned.

**STEERING CABLE:** Refer to the literature supplied for your steering system as to proper lubrication and maintenance.

**BILGE PUMP:** Check your bilge pump(s) often to ensure that it is operating efficiently. Remove any debris that you find in the bilge. It is important to keep the bilge area clean. Wash it down with a good household detergent or a bilge cleaner available at a marine supply store to prevent a build-up of grease and scum, then rinse well with clear water **WITH YOUR BILGE PUMP RUNNING.** If your pump seems to lag, remove the head from the base and check the impeller to ensure that there is no debris lodged in it. See your dealer if there is still a problem with water removal.

## OPERATIONAL MAINTENANCE

Unless you are an expert mechanic, there are some engine maintenance functions that are better performed by your dealer, such as service to your starter motor, alternator, thermostat, timing and electrical ground connections.

Further recommendations for the operational maintenance of inboard drives that can be accomplished by you or your dealer will follow. It is advisable to familiarize yourself with them, even if you have your dealer service your boat.

**PROPELLER:** Here are a few tips for the installation (or re-installation) of the propeller.

**A NOTICE OF CAUTION:** A propeller can be very sharp so be careful to handle it with that thought in mind. (It's a good idea to wear a pair of protective gloves when handling any propeller.)

Now, for installation, follow these steps:

1. Before placing the propeller on the shaft, note the keyway on the shaft and in the propeller. Make sure that the key rides freely in the shaft keyway as well as the propeller keyway. Lightly filing the key's flat sides to remove burrs may be necessary. Then place the key in the shaft keyway. Now match the installed key to the propeller keyway. (See illustration.) Once aligned simply push the propeller onto the shaft. You'll hear a solid "thunk" as the propeller is seated. **THE PROPELLER WILL ONLY SLIP ON IN ONE DIRECTION SINCE THE SHAFT AND PROPELLER BORE ARE TAPERED.**

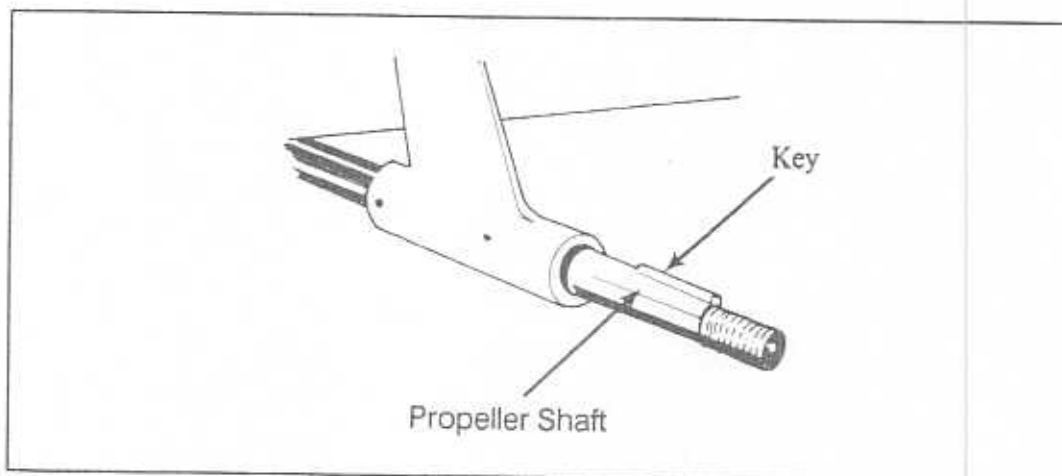

4



## OPERATIONAL MAINTENANCE

2. Next, place the castle nut on the shaft and wrench tighten, making sure that the key is firmly seated and that it doesn't protrude from either end of the keyway.

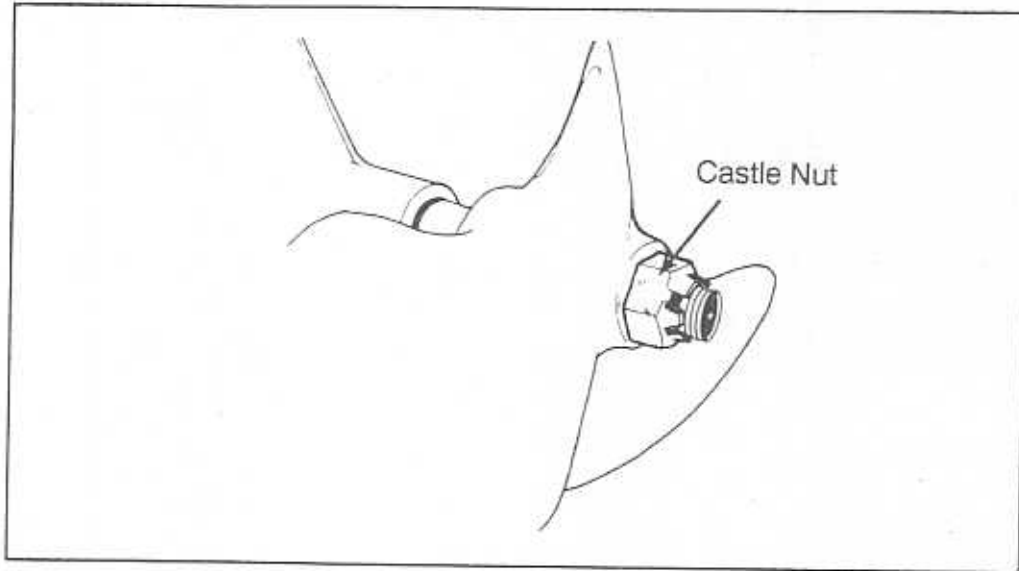

3. When the castle nut is tight, look for the cotter pin hole and insert the stainless steel cotter pin (see illustration). With a light tap, drive the cotter pin down through the slot and hole so that its rounded top rests snugly upon the hole. Next, with a pair of pliers, bend the loose ends of the cotter pin back against the shaft and tap them lightly to secure.

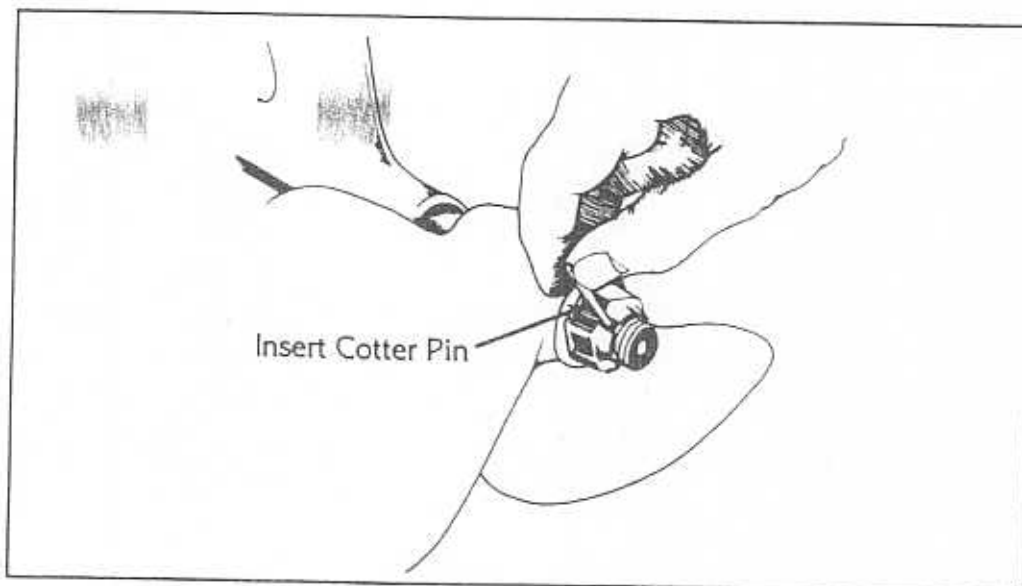

## OPERATIONAL MAINTENANCE

To remove propeller, remove the cotter pin. Loosen the castle nut and turn to end of shaft. Do not completely remove castle nut. Use a propeller puller available at most marine supply stores.

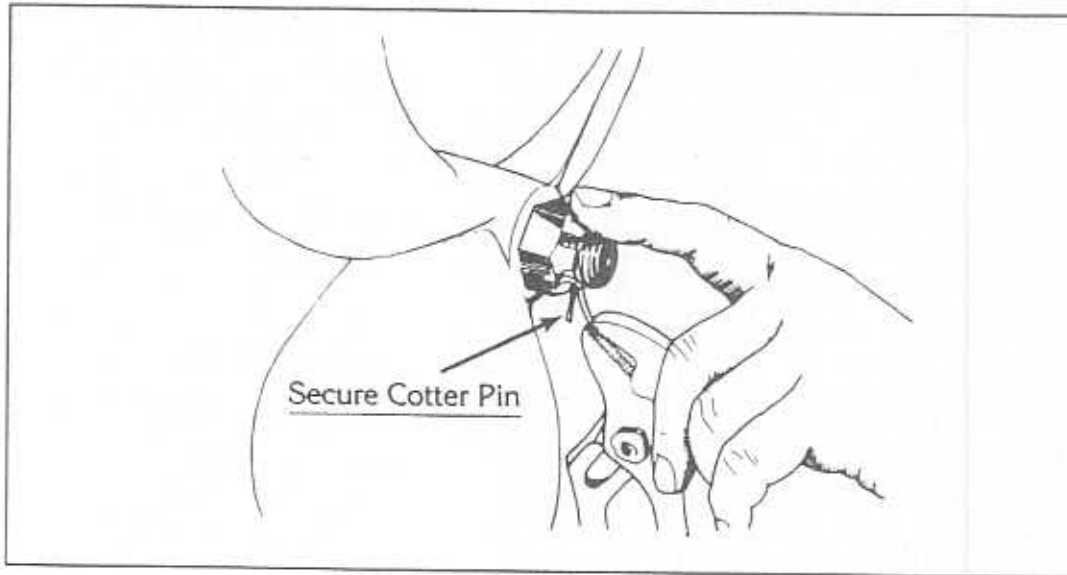

4

**A FINAL CAUTIONARY NOTE:** WE'LL REPEAT OUR FIRST CAUTION. BE CAREFUL OF THE HANDLING OF YOUR PROPELLER. A SHARP PROPELLER CAN INFLICT A PAINFUL CUT.

## OPERATIONAL MAINTENANCE



Stuffing Box

**PROPELLER SHAFT STUFFING BOX:** The "stuffing box" or "packing gland" is designed to prevent the intrusion of water past the through-hull fittings that accommodate moving parts -- the propeller shaft and the rudder post. These devices contain a lubricated fibrous packing that acts as a seal when they're tightened down.

The propeller shaft stuffing box should be checked frequently (with the engine off) for the presence of any water leakage other than a few drops per minute (this rate is acceptable and expected). If you view a steady stream of water or an excessive drip rate, then you need to tighten the stuffing box. If you own a Ski Nautique or a Sport Nautique, simply pry up the round plate on the floor behind the engine cover and visually inspect the box. See illustration for that which you can expect to see.

If you own a Nautique Super Sport, you must remove the floorboard to access the v-drive gear and the stuffing box below. The directions for loosening or tightening the shaft packing nut will be reversed due to a left hand threaded stuffing box.

If tightening is required, follow the procedures with careful attention to models:

1. Gain access by raising the removable floorboard and setting it aside. (To accomplish this, Ski Nautique and Sport Nautique owners must disconnect the engine cover, remove the stern seat and the stern panels covering the gas tank, then simply lift and set aside the flooring.)

## OPERATIONAL MAINTENANCE

2. Cut the safety wire (this wire prevents the packing gland from backing off entirely in the event of extreme looseness). See illustration.

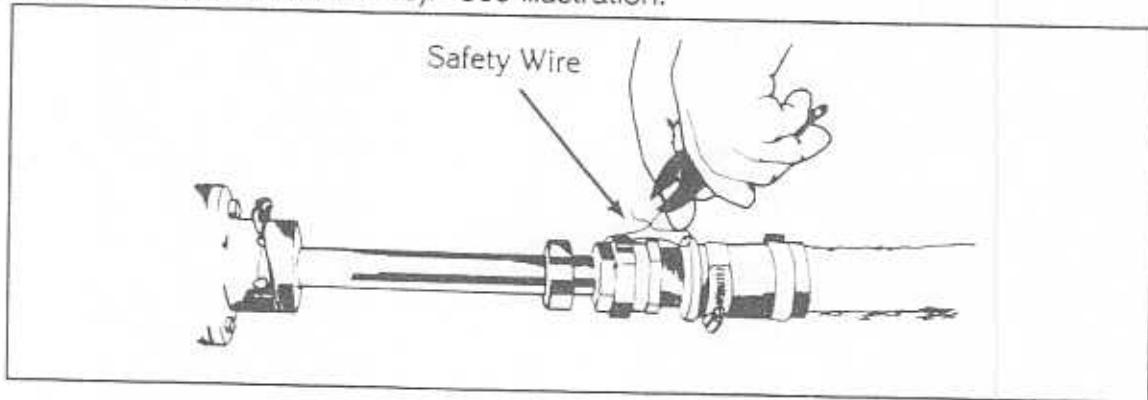

3. Using two pipe wrenches, one to stabilize the gland nut (the large nut to forward) and the other applied to the locking nut, loosen the locking nut with a counter-clockwise motion (loosen toward the left side of the boat). See illustration.

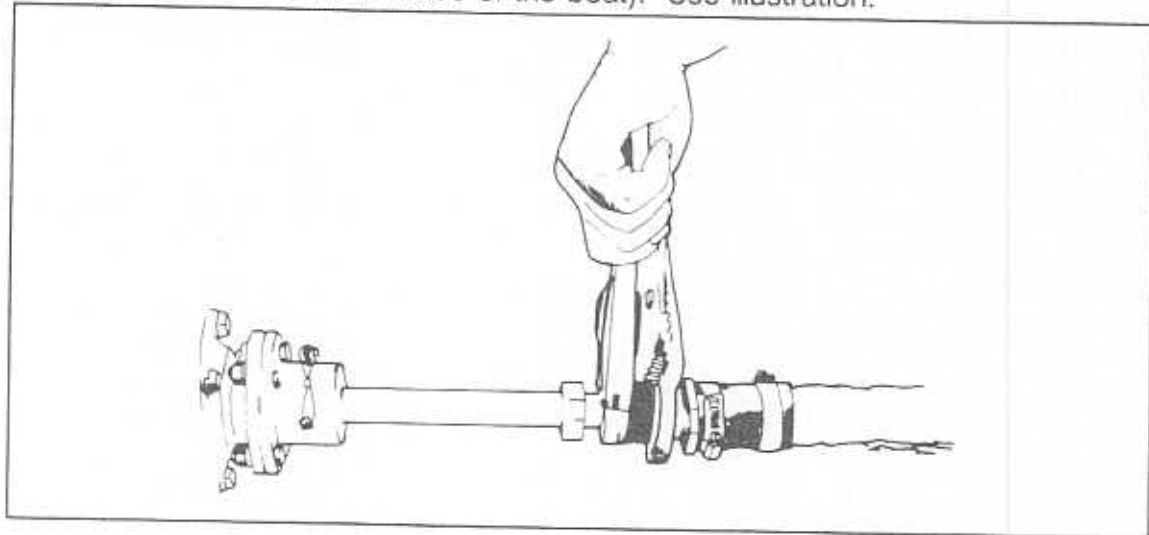

**4**

## OPERATIONAL MAINTENANCE

4. Now, **HAND-TIGHTEN** the gland nut (again, toward the left side of the boat) until the leakage stops and the prescribed dripping is achieved. See illustration.

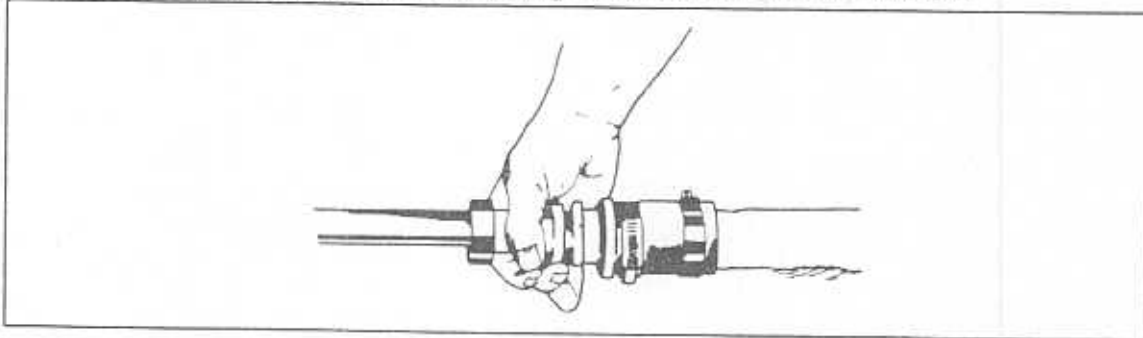

5. Next, using wrenches as in step 3, re-tighten the locking nut by turning toward the right side of the boat. Make sure that it is **VERY TIGHT**. Super Sport owners must remember that the shaft packing nut tightens in the opposite direction of a Ski Nautique illustrated here.

6. Now, take a flat-headed screwdriver and temporarily loosen one of the hose clamps to the rear of this assembly and rotate the assembly until the safety wire eyelet is easily accessible.

7. Finally, replace the safety wire as shown in the illustration. **NOTE; BE SURE TO REPLACE THE SAFETY WIRE. THIS IS VERY IMPORTANT. USE A STAINLESS STEEL SAFETY WIRE OF AT LEAST .032 GAUGE.**

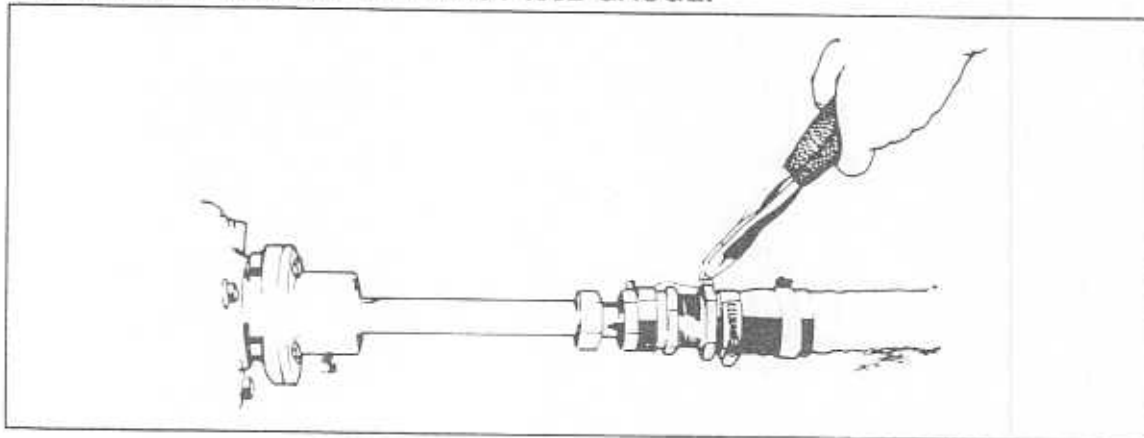

This operation serves to compress the packing within the gland nut creating a tighter seal. If, in the unlikely event you still experience leakage, consult your dealer.

4

## OPERATIONAL MAINTENANCE

**RUDDER PORT STUFFING BOX:** The rudder port stuffing box serves the same purpose as the propeller shaft stuffing box. That is, it is designed to prevent excessive intrusion of water into your boat. There are two differences that you should be aware of. One, there is no safety wire on it, since its movement functions and range of motion differ; and two, being in a vertical position as opposed to the horizontal, the counter-clockwise direction in loosening the locking nut would be accomplished by turning the wrench toward the starboard or right side of the boat. Otherwise, the principle is the same.

**THROUGH-HULL FITTINGS:** All fittings that actually pass through the hull on a wetted surface are glassed into the hull and become a part of it. They are not user serviceable and should not be tampered with. It's highly unlikely that water leakage would occur at these points, but should you discover any, your dealer should be contacted.

**QUICK DRAIN OIL SYSTEM:** This system allows you to drain the oil from your crankcase quickly and efficiently. It consists of a tube attached directly to the bottom of the crankcase and held at the drain end with a quick-release snap. (See illustration for location.) You will note a small plug on the end. This is removed with use of two open-end wrenches (5/8" and 3/8")

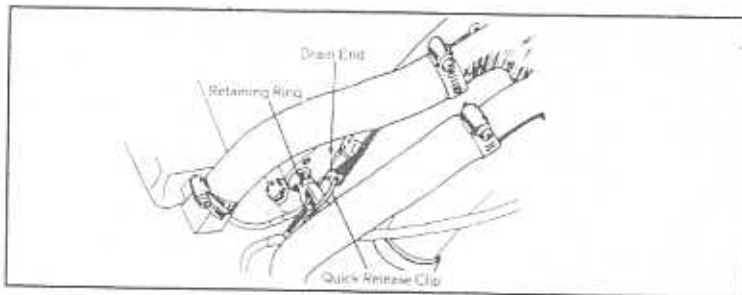

First, make sure your boat is on its trailer or otherwise suspended.

If you own a Ski Nautique or a Sport Nautique, remove the bottom through-hull plug at the front of the engine and then feed this tube through the hull bottom. (Feed it all the way through, making sure that there are no kinks or loops in the tubing.)

## OPERATIONAL MAINTENANCE

Super Sport owners need to remove the transom drain plug and feed the tube through the transom drain, making sure the hose does not become kinked or looped.

Next, remove the plug and drain the oil into a container placed under the boat. **NOTE:** Most efficient draining will be achieved by running your engine with a cooling water source until it is warm, allowing several minutes for the oil to settle, then draining the oil. The preferred method, however, is to let the oil drain overnight. Consult your engine manual for the proper viscosity of engine oil to be used for replacement.

### **BE SURE THE ENGINE IS OFF WHILE DRAINING YOUR OIL.**



**Quick drain oil kit**

**4**

**PROPELLER SHAFT/ENGINE ALIGNMENT:** Periodically check alignment by visually inspecting and turning the prop to ensure that it turns freely with no binding. If it binds you should see your dealer or a reputable mechanic familiar with inboard drives. A more thorough inspection may thwart a potentially damaging misalignment problem.

**CAUTION! AVOID PERSONAL INJURY.** Propeller edges are sharp, and if not handled carefully, can cut you. **ALWAYS** wear a pair of durable work gloves when touching the propeller. **BE CERTAIN** that engine is **OFF** before approaching the boat's transom area. **NEVER** check alignment while the boat engine is running. While checking alignment, **BE VERY CAREFUL** to clear your head of the boarding platform and boat hull before rising. By standing up too quickly, you could hit your head and injure yourself.

## OPERATIONAL MAINTENANCE

**TRANSMISSION DRAIN AND REFILL:** Your transmission fluid should be drained and refilled as set forth in your engine manual. As an aid to you, see the illustration for a good method of accomplishing this. Small hand pumps are available at most marine supply stores. See your engine owners manual for additional information.

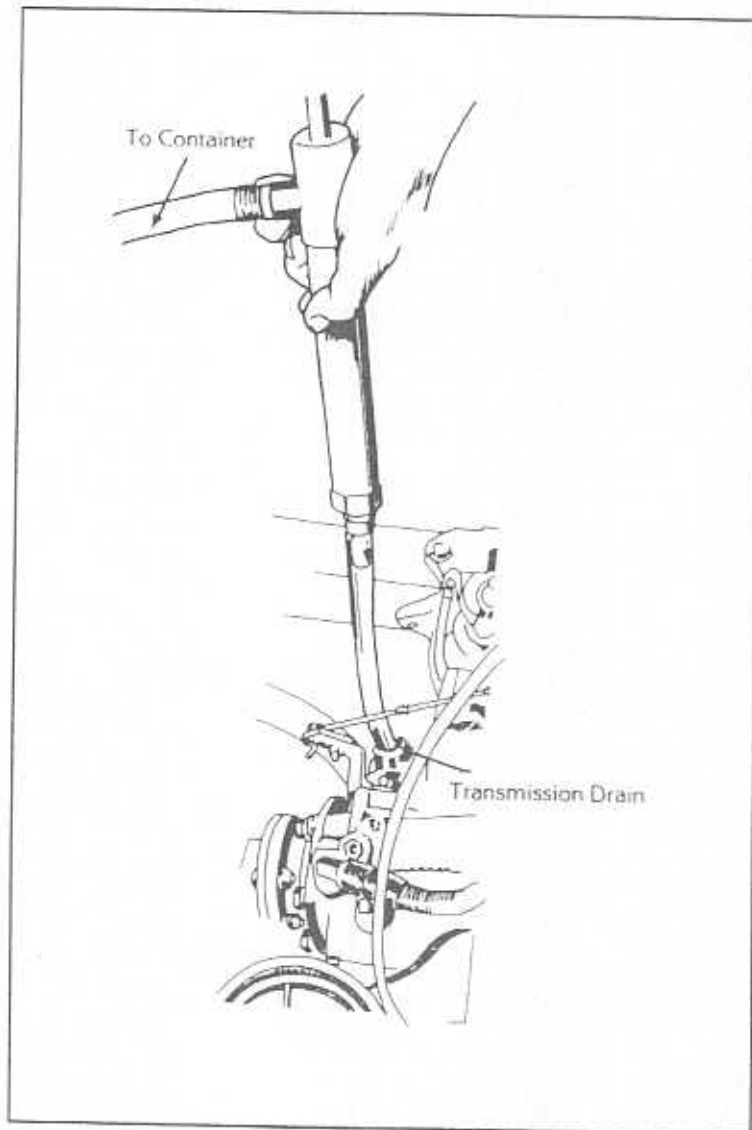

4



## OPERATIONAL MAINTENANCE

**FRESH WATER FLUSHING:** IF YOU USE YOUR BOAT IN SALT WATER, FRESH WATER FLUSHING OF YOUR ENGINE AND COOLING SYSTEM IS A MUST.

Flushing the system by running the boat in fresh water will suffice, but if that is not possible Correct Craft offers a flush kit for this purpose as an option. The diagrams to aid installation are included with the kit.

The illustration shows the fitting properly hooked up to the stern of your boat. The relief valve in this fitting prevents excessive water pressure from being applied to your engine. We strongly recommend the use of this system.

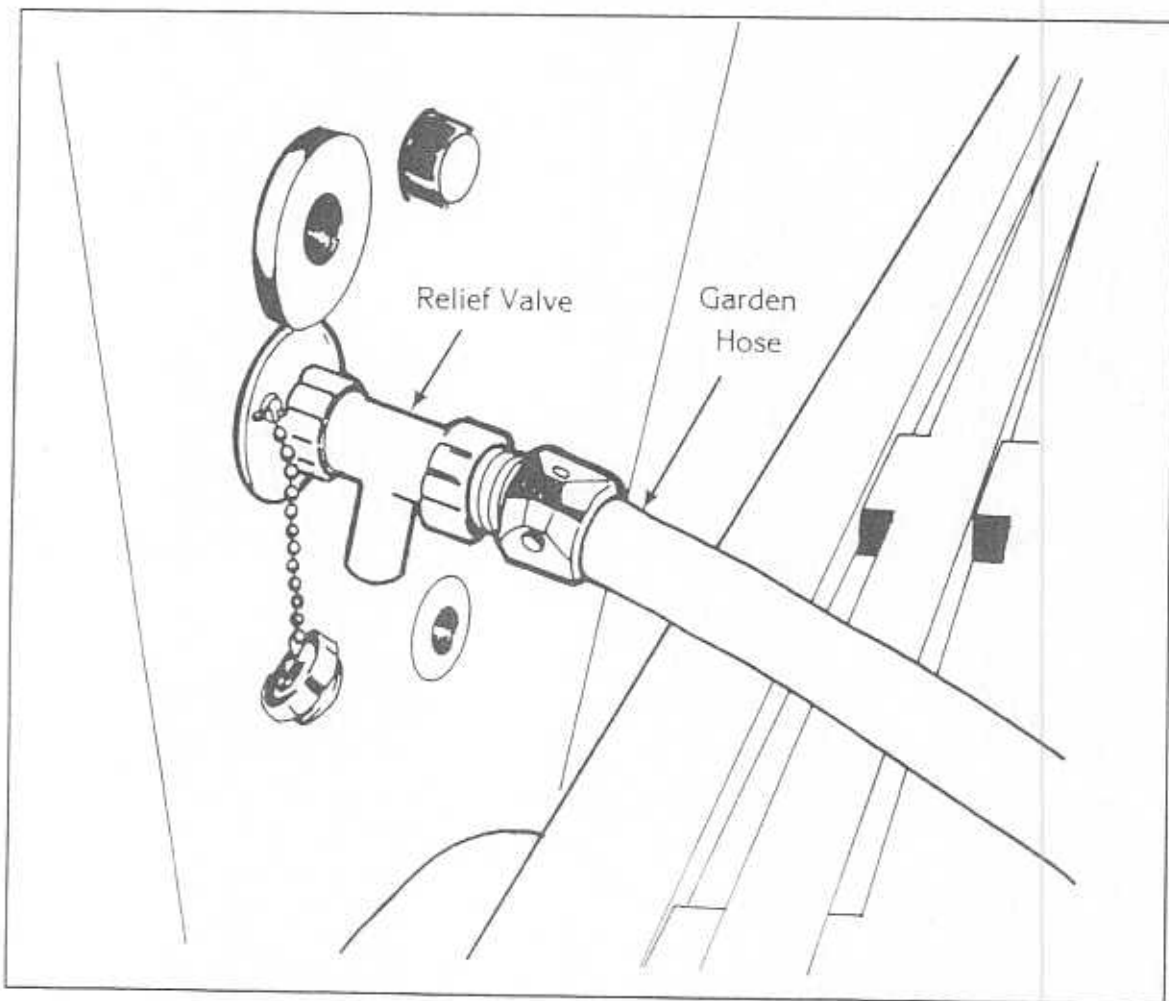

IF THIS SYSTEM IS NOT EMPLOYED IN YOUR BOAT AND YOU USE IT IN SALT WATER, THEN WE ADVISE YOU TO SEE YOUR DEALER FOR ALTERNATE METHODS OF FLUSHING.

## OPERATIONAL MAINTENANCE

**BATTERY MAINTENANCE:** Many boaters who are meticulous about maintaining their water skis, fishing equipment and motor boat in tip-top shape for some reason are inclined to ignore their boat's battery. But the battery is as important to the operation of your rig as any item aboard. Here are several suggestions for the care and cleaning of your marine battery.

### **THINGS YOU SHOULD DO:**

**DO** wear eye protection and rubber gloves when working on or around batteries.

**DO** take care when connecting or disconnecting battery charger cable clamps. Be sure charger is turned off and unplugged from power source when making or removing connections. Poor connections are common causes of electrical arcs which could cause an explosion.

**DO** use a voltmeter or hydrometer to check the battery charge condition.

### **THINGS YOU SHOULD NOT DO:**

**DO NOT** smoke or bring a flame near a battery at any time.

**DO NOT** place your head directly above a battery when making or breaking electrical connections.

**DO NOT** use a metal object to spark between battery posts to check for charge condition.

**DO NOT** make or break electrical circuits at the battery terminals; a spark usually occurs when a live circuit is opened or made.

To clean your battery, wash down the battery case with a diluted ammonia or baking soda solution to neutralize any acid, then flush with fresh water. Keep the fill/vent caps tight so the neutralizing solution does not get into the battery cells.

The electrolyte level should be checked every 30 days. The level should be maintained between the top of the plates and the bottom of the fill/vent cap opening by adding distilled water. Do not overfill and remember that batteries contain sulphuric acid which can cause severe burns.

## OPERATIONAL MAINTENANCE

### WINTERIZING

**APPLICABLE TO BOTH HULL AND ENGINE:** Off season storage procedures vary accordingly with factors such as type of storage, climate and length of storage. These variables preclude recommendation of specific procedures. Instead Correct Craft advises that you consult your engine owners manual and seek advice from your dealer or the manager of the storage facility.

One important point should be mentioned, however, and that is the proper way to cradle your boat. Our "A" frame trailer was designed for your Correct Craft boat with longitudinal supports as the preferred method of cradling, since they allow for an equal distribution of weight.

If you don't have a trailer, then a cradle should be used that takes into account the even distribution of weight.

If you have no dealer or marina nearby and must arrange off-season storage yourself, please feel free to contact your regional warehouse as provided in section one of this manual for recommendations for your particular area.

Speedometer maintenance and winterizing are covered under "Controls and Gauges."

If you use a mooring cover, **DO NOT** put it on when the interior of the boat is wet and/or hot. It will trap moisture that can lead very quickly to mildew. Try to provide some ventilation if your cover does not have built-in provisions, even if you have to leave a portion of it unattached. Even the natural build-up of moisture can have unhappy consequences.

Late in 1985, Correct Craft initiated a change from a water filter manufactured by Vetus to one produced by Sherwood. The Sherwood filter bowl remains full of water even after the rest of the raw water system has been drained. **To properly winterize your boat, the filter bowl should be removed and emptied. Be careful to not lose the rubber O-ring that seals the bowl to the cap.** If the water is not removed, the bowl could be subject to freeze damage and therefore cause overheating problems during the next season.

4

## OPERATIONAL MAINTENANCE

**CHECK FOR WATER IN YOUR FUEL SYSTEM:** If you are planning to place your boat in storage this winter, it would be a good idea to check for, and remove, any water in the fuel system. Even if you are not going to store your boat during the cold months, it is a good time to check for water in the water separator. Even a small amount of water left in the system for several months can result in damage.

The water separator can be drained by removing the drain plug at the bottom of the canister. An incoming air source must be created by loosening and removing the incoming fuel hose. **TAKE GREAT CARE TO CONTROL THE LOSS OF FUEL BY CLAMPING THE HOSE PRIOR TO ITS REMOVAL.** Once the canister is drained, coat the threads of the drain plug with a fuel resistant pipe thread sealer then replace and tighten. Then reconnect the fuel hose, tighten the fastener and remove the clamp. **IT IS IMPERATIVE THAT THE THREADS BE SEALED PROPERLY TO AVOID A POSSIBLE FUEL LEAK.**

It is a good idea to periodically check your fuel filter to expose signs of water in the tank. If it appears there is an undue amount of water build-up in the tank, position your boat at an angle to make the water collect at the low end of the tank. Try removing the water with a siphon or manual pump. Do not use an electric pump as it can cause a spark and an explosion.

It is a good practice to store your boat with the gas tank nearly full and to add a fuel stabilizing fluid that slows down the rate of fuel decomposition. You can purchase this at most marinas or auto supply houses. Add the stabilizer to the nearly full tank then run the engine to circulate it throughout the fuel system and into the carburetor. This will help keep the seals from decaying and cracking. Always follow the manufacturer's recommendations for proper mixing. Consult your engine owner's manual for more information on fuel system lay-up procedures.

A nearly full tank will not allow condensation to form on its inner surfaces. An empty tank can pick up a lot of water through repeated condensation. (It is a good idea to keep a nearly full tank at all times to reduce the chance of condensation build-up even after daily usage)

**NOTE: GASOLINE EXPANDS IN HEAT. ALLOWANCE MUST BE MADE FOR SUCH EXPANSION. DON'T OVERFILL IF BOAT IS NOT STORED ON LEVEL SURFACE OR IF IT IS EXPOSED TO HEAT.**

**CAUTION: USE ONLY CORRECT CRAFT APPROVED PARTS AND ACCESSORIES ON YOUR CORRECT CRAFT BOAT. THESE PARTS AND ACCESSORIES SHOULD BE INSTALLED ONLY BY CORRECT CRAFT OR AN AUTHORIZED CORRECT CRAFT DEALER.**

## CAPACITY PLATE

The capacity plate is used by boat manufacturers, such as Correct Craft, Inc., participating in the National Marine Manufacturers Association Certification Program. Manufacturers submit an example of every model under 26 feet in length for inspection.

A capacity plate bears the following information permanently marked thereon and is attached to the boat so as to be visible and legible from the position designed or normally intended to be occupied by the operator of the vehicle when underway.

The total weight of persons, gear and other articles placed aboard which the vessel is capable of carrying safely under normal conditions.

The maximum number of persons allowed on the boat.

The information appearing on the capacity plate is applicable under normal conditions and special care must be used in any other than normal conditions.

Check the capacity plate on your boat and please abide by these limits to assure safety for yourself and other boat occupants thereby enjoying the pleasure of boating with the least possible risk.

5

## HULL IDENTIFICATION NUMBER

The hull identification number (or HIN) is a requirement of the U.S. Coast Guard for boat manufacturers. It is a standardized numbering system that assigns a specific sequence of numbers and letters to a specific boat, (just as on a car).

This number is molded into the hull. You will find it on the upper right-hand side of the transom just below the gunwale. (See illustration for location.) It is not a bad idea to make a record of this number and keep it in a safe place away from the boat.

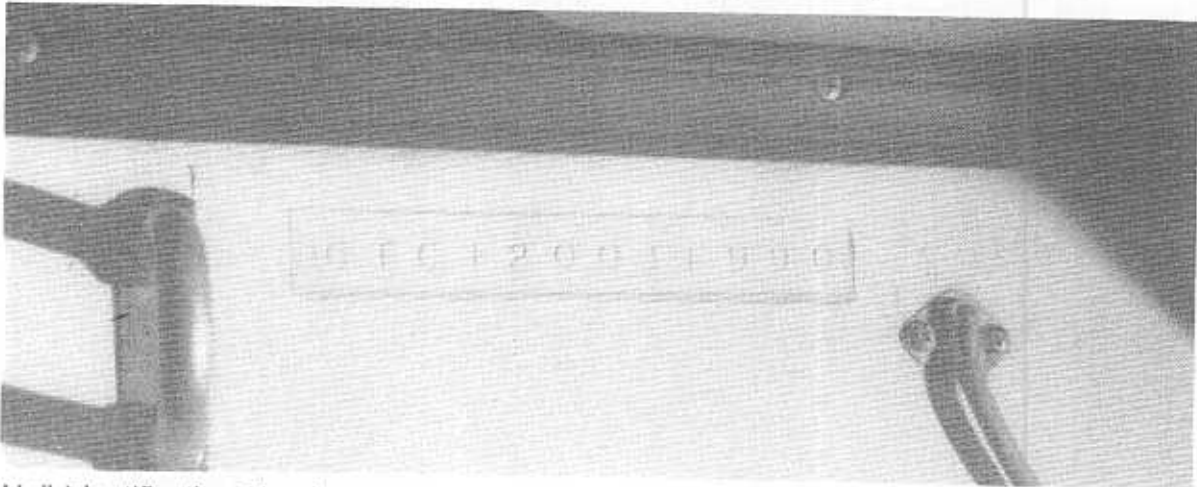

Hull Identification Number

Here is a brief explanation to help you understand the information shown. Again, refer to the illustration.

The first three digits are letters designating the manufacturer's code (CTC being Correct Craft's code). The next five digits are the serial number (no two are alike). The following digit is a letter from "A" through "L" designating the month of manufacture, that is to say "January" through "December".

The following will show the alphabetical codes that relate to this letter.

A = January	G = July
B = February	H = August
C = March	I = September
D = April	J = October
E = May	K = November
F = June	L = December

After this you will find three more numbers. The first of these represent the last digit of the year of manufacture and the final two numbers state the MODEL year. (Should your boat be built from September through December, then the final two numbers will show a number one year higher than the year of manufacture.)

To sum, in the example shown, the first three letters tell you that the boat was manufactured by Correct Craft. Following that is a five-digit serial number. Next you will see that it was built in the month of June in 1990 and that it is a 1990 model year.

## COMMON SENSE BOATING

**Before you start your engine**, whether you are a newcomer to boating or a seasoned skipper, we suggest that you read this chapter. It can't hurt. We at Correct Craft want you to enjoy your boat. But, above all else, we want you to come back to shore safely. So, here are some tips for happy boating.

Become familiar with the free pamphlets available regarding such things as Rules of the Road, Navigational Aids and Federal Requirements for Recreational Boats. (Your dealer can supply these, as can organizations such as the United States Coast Guard Auxiliary and the U. S. Power Squadrons.) Also, check with your state's boating publications (regulations vary from state to state). The Coast Guard's "Rules of the Road" really translate into **COMMON SENSE**.

If you think of it as driving a car, it becomes a bit easier.

In a "meeting situation," that is, a vessel coming towards your bow, you should pass that vessel, keeping it on your port (left) side. (Same as when driving a car on a highway.)

In a "crossing situation," that is, another vessel passing in front of you, if the vessel is on your starboard (right) side, that vessel has right-of-way.

In an "overtaking situation," the boat being overtaken (passed) has the right-of-way. The overtaking boat should pass on the port side of the boat being overtaken with a single blast of the horn. If for safety reasons it is required to overtake on the starboard side, two blasts from your horn are required.

You may encounter an unpowered vessel such as a sailboat or canoe. The unpowered vessel **ALWAYS** has right-of-way. However, if a sailboat is also being powered, it must abide by "Rules of the Road."

Do not **DEMAND** the right-of-way, even if you are correct. The only **REALLY** correct move is to avoid a collision.

**Some things that are not covered in "Rules of the Road:"** Elsewhere in this manual, we mention to **NEVER** use alcohol in your fuel tank. It can damage your engine. Similarly, alcohol in your body while operating a boat can ruin your life. **NEVER OPERATE YOUR BOAT UNDER THE INFLUENCE OF ALCOHOL OR OTHER CONTROLLED SUBSTANCES!!!**

**DO NOT** let anyone sit on the bow of your boat while under power. They **COULD** fall off and not be able to avoid the propeller. In the case of open bow models, bow seating is available, however care should be taken to avoid obstructing the driver's field of vision. Do not allow objects or extremities to hang from the bow or gunwales.

**DO** check visually before making any turn. (Someone else may **NOT** be following the "Rules of the Road.")

## COMMON SENSE BOATING

**DO** keep a visual check for vessels off the stern. That is an area where accidents can happen very quickly.

**DO NOT STAND** while the boat is under way.

**DO** sit on the seating provided while under power and **INSIST** that your passengers do likewise.

**DO NOT** sit on the gunwales, decks, seat backs or engine cover while under power.

**DO** have a Coast Guard Approved PFC (Personal Flotation Device) on board for each person. It is not only required, but **common sense**.

**All passengers must remain in their proper seats at all times while the boat is under power.**

**CAUTION: THE ENGINE COVER IN YOUR BOAT IS NOT A SEAT. DO NOT SIT ON THE ENGINE COVER WHILE THE BOAT IS UNDERWAY.**

There are no brakes on boats and both the water current and wind velocity affect your ability to stop a boat safely. The driver must exercise caution at all times to maintain control of the boat, especially to maintain a reasonable distance from all potential areas of danger. Decrease speed to a minimum in all areas of potential hazardous navigation and in all conditions of reduced visibility. Be alert for posted speed limits, swimming areas, no wake zones and other restrictions. They are there for a reason. Common sense plus courtesy adds up to safety.

States have varying regulations regarding water sports activity. Check the local and state agencies in your area to determine laws regulating water sports which require boat participation. These laws were written to protect both boaters and water sports enthusiasts. Some states require that an observer be in the boat while pulling a skier, others require only a mirror. Learn and follow the laws where you will be boating. **Correct Craft recommends that you have an observer in the boat with the driver at all times that a person is in tow.**

All of us at Correct Craft are proud that you have chosen **our** boat to be **your** boat, and we want you to enjoy it to the fullest. So, please, enjoy your Correct Craft **SAFELY!**





## COSMETIC CARE

**MAINTENANCE** is the key word in keeping your hull and deck surfaces in good-looking condition. As with an automobile, atmospheric pollution, sun, tree residue, coatings from water and other factors will dull your finish.

To help maintain the lustre of your boat, hose down your hull after each use. This will help to remove any debris and water-borne materials that have accumulated on your hull during use.

Regularly wash your boat with mild detergent such as dishwashing liquid or boat washing formula available at marine supply stores. Use a soft sponge or towel, just as you would do with your car, and dry with a chamois cloth to prevent water spots.

The bottom is an especially important area to keep clean since any build-up of the natural coatings from water will create drag and reduce the boat's efficiency.

Wax and polish the hull and bottom periodically as you would a car. Fiberglass waxes and polishes are available at marine supply stores. There are so many products that we can only give general recommendations. You will discover your own favorite brands and remedies. There is a wealth of valuable information on the labels of products that you purchase. Read them carefully **BEFORE** you purchase them and if you decide to use them, **FOLLOW** the instructions.

If you must leave your boat in the water, there are compounds to remove algae build-up on your hull. Some of these can be caustic, and you should pay special attention to the cautions on the label. If your finish **DOES** develop a chalky look over a period of time due to exposure to sun, there are fiberglass compounds available at marine supply stores with varying degrees of abrasiveness. (You should definitely use products specifically formulated for fiberglass.) After the use of these products, a reputable fiberglass polish is highly recommended.

**DO NOT USE ANY TYPE OF COMMON HOUSEHOLD SCOURING PADS OR SCOURING POWDERS SUCH AS THOSE USED FOR CLEANING SINK BOWLS AND THE LIKE. YOU WILL PUT FINE SCRATCHES IN YOUR FINISH THAT WILL RESULT IN A DULL APPEARANCE AND WILL TRAP DIRT.**

**UNLESS YOU HAVE EXPERTISE IN GELCOAT DAMAGE REPAIR, DO NOT TRY TO EFFECT REPAIRS SUCH AS CRACKS OR HOLES YOURSELF. INSTEAD, TAKE YOUR BOAT TO YOUR DEALER OR TO A REPUTABLE FIBERGLASS REPAIR PERSON. THE GELCOAT AND THE GLASS BENEATH CAN BE REPAIRED SO THAT THE DAMAGE IS NOT NOTICEABLE. BUT MAKE SURE THAT FIBERGLASS REPAIRS ARE EFFECTED QUICKLY. FAILURE TO MAKE REPAIRS TO DAMAGED FIBERGLASS CAN LEAD TO SERIOUS STRUCTURAL DAMAGE.**



## COSMETIC CARE

Your boat's finish can be kept in showroom condition by KEEPING it clean and bright. The real chores begin when you allow it to become chalked and dirty. Our advice to you is pay attention to detail on a regular basis and you will have a boat to be proud of for a long time.

**CAUTION:** Correct Craft is dedicated to producing the finest boats available. Gelcoat remains the most effective and efficient cosmetic finish a boat can have. There is, however, a phenomena that occasionally causes a bubbling or blistering effect. Unlike others in the gelcoat industry and the marine industry, Correct Craft warranties gelcoat for a 90 day period to the original retail purchaser. Correct Craft adheres to its policy as stated in the "Correct Craft Limited Warranty."

Correct Craft also offers a preventive maintenance suggestion: If you are to moor your boat in water for any period of time, the wetted surface of your hull should be painted with an epoxy paint formulated for blister prevention.

**CARE OF TEAK:** Teak is a unique wood used for marine applications for a couple of reasons. It is an open cell wood that is highly resistant to the dry-rot associated with many other untreated woods and is also impervious to marine organisms. IF YOUR BOAT HAS TEAK COMPONENTS, DO NOT COAT THEM WITH ANY KIND OF VARNISH OR POLYURETHANE COATING. The use of these coatings defeat the natural "breathing" properties of teak and it can then deteriorate from within.

If you have teak on your boat, when new, it is a rich gold-brown color. After a period of time, exposure to the elements will cause it to turn a weathered grey color. This should not affect its durability, but you may want to return it to the luxurious color that you originally noticed.

In that case, we suggest that you purchase a good two-part teak cleaner from a reputable marine supply store **BE SURE TO FOLLOW THE MANUFACTURER'S INSTRUCTIONS ON THE LABEL.** (You should use these products in an open space and be careful to avoid spillage on any other parts of your boat.)

**CARE OF METAL:** Keep all metal work rinsed and wiped dry. Periodically polish it with a commercially available metal polish to remove caustic substances such as air-borne pollution and natural body oils from your hands. **DO NOT LET DIRT AND POLLUTANTS GET AHEAD OF YOU ON YOUR METAL PARTS!**

**CARE OF GLASS:** Your windshield, mirrors and gauge faces all deserve the same attention as the other parts of your boat. Clean them often with commercially available glass cleaners such as "Windex" or a mixture of vinegar and water. Use paper towels, terry cloth rags or wadded-up newspaper. There are few things that can dress up an already clean boat more than sparkling glasswork.



## COSMETIC CARE

**STAINS:** If your boat is parked under a tree, leaves and debris containing acidic ingredients such as tannic acid may stain your gelcoat and/or upholstery. If soap and water do not readily remove these stains, try a mild abrasive like Soft Scrub applied with a wet sponge or wipe lightly with Fantastic. Correct Craft Customer Service can provide additional information for removing persistent stains.

**CAUTION:** HOUSEHOLD CLEANING PRODUCTS FREQUENTLY CONTAIN BLEACH, BE SURE TO RINSE YOUR BOAT THOROUGHLY WITH FRESH WATER AFTER USE.

**CARE OF UPHOLSTERY:** Your Correct Craft boat is equipped with the finest vinyl upholstery available, but it needs attention to ensure its continuing lustre. The first thing you should know is that vinyl can become dry and brittle when exposed to natural body oils, suntan lotion, dirt and, of course, sunlight.

CLEAN YOUR UPHOLSTERY ON A REGULAR BASIS WITH A LIGHT DETERGENT AND WATER. BE SURE TO RINSE IT WELL WITH FRESH WATER AND WIPE DRY WITH A SOFT CLOTH OR TOWEL.

Here are a few tips:

**DO NOT step on your upholstery if at all possible, since heavy pressure on small areas can cause eventual tearing of the material.**

**DO NOT** use bleach on the interior fabric of your boat.

**DO NOT** use a mooring cover when the boat is wet and/or hot. It causes condensation which in turn will create mildew. (Leave adequate ventilation when using a mooring cover to ensure a free flow of fresh air.)

If you do not have a garage or other covered protection for the times that your boat is not in use, then cover your upholstery with towels or a drop-cloth, making sure that the upholstery is dry.

**DELUXE INTERIORS:** Some boats are equipped with interiors whose side surfaces touch, such as a wrap-around seating. This type of seating should be raised, cleaned **AND DRIED** before lowering back into position. **THIS IS IMPORTANT TO PREVENT TRAPPED MOISTURE FROM CREATING A BUILD UP OF MILDEW.** (Any trapped moisture will lead to mildew.)

**NOTE:** Should your upholstery become damaged for any reason, then take your boat to your dealer or to a reputable repair person as soon as possible to prevent further damage.



## COSMETIC CARE

**CARPET:** Regularly vacuum your carpeting to remove loose debris so that it does not abrade the fabric. Also, be sure to wash down the carpeting with a mild detergent and water using a simple household brush. Then rinse well with clear water.

**CAUTION:** When performing any interior washing and rinsing, be sure that the boat is securely cradled out of the water with the drain plug removed. If you wash your boat's interior while the boat is in the water. Plan for proper waste water removal and disposal. **DO NOT EXPEL SOAPY WASTE WATER OVERBOARD! IT CAN CREATE AN ENVIRONMENTAL HAZARD.**



# YOUR BOAT

## SKI NAUTIQUE SIGNATURE EDITION

### S P E C I F I C A T I O N S

CONSTRUCTION:	FIBERGLASS
LENGTH (WITH THE PLATFORM):	20'11"
LENGTH (WITHOUT THE PLATFORM):	19'6"
BEAM:	91"
DRAFT (NOT UNDER POWER):	24"
APPROXIMATE WEIGHT (W/STANDARD FEATURES)	2340 LBS.
LIFTING RINGS (BETWEEN CENTERS):	17'9"
FUEL CAPACITY:	26 GALLONS

## YOUR BOAT

### CONTROLS AND GAUGES

#### SKI NAUTIQUE DASHBOARD CLUSTER

First, take a look at the illustration of your dash and familiarize yourself with the location of the various controls and gauges.

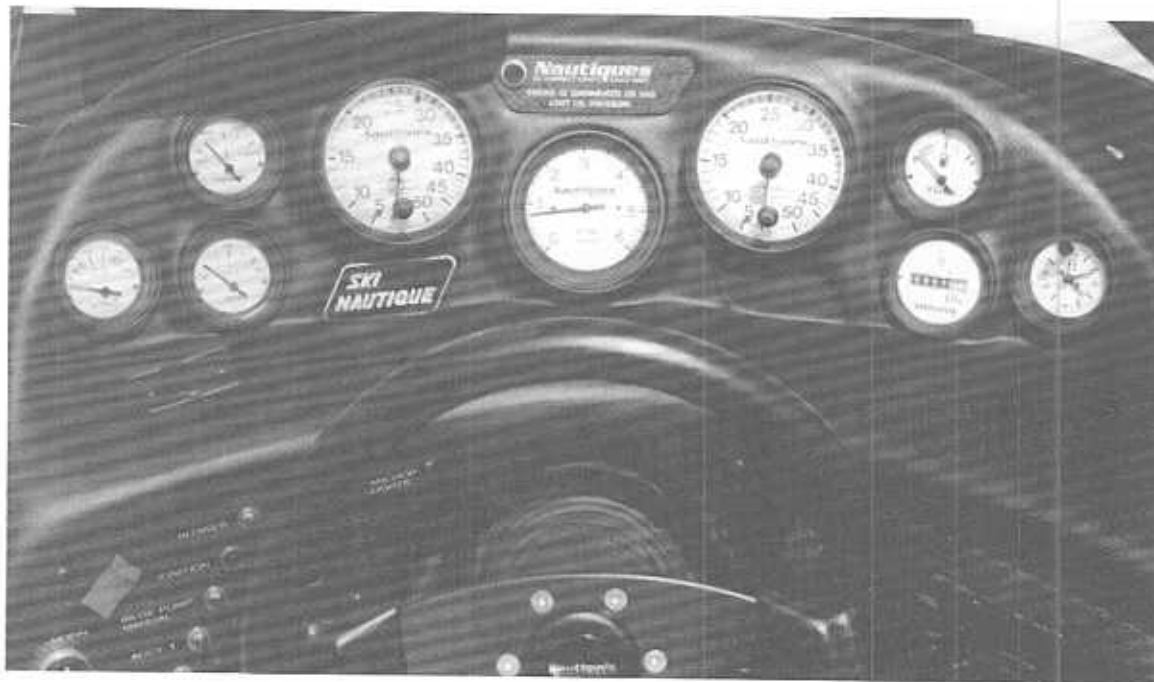

Next, read and understand the cautionary labels affixed to your dash.

The ten push button circuit breakers function as switches. In the "OFF" position the button will be sticking out. To turn on a particular function, simply push in the corresponding button. When the circuit breaker is on, the LED indicator will be lit. The ignition circuit breaker LED is lit only when the ignition key is in the "ON" position. In the event of a current overload, the circuit breaker will trip and the button will pop out into the "OFF" position.

Now, let's go over the controls and gauges on your Ski Nautique dash panel:

## YOUR BOAT

**PUMP/AUTO:** This switch operates the electronic bailer using automatic electric bilge pump switch. (Correct Craft's walk over models have two electric bilge pump switches.) If the bilge takes in water beyond a certain pre-set level, the electric sensor will automatically turn on the pump until the water is below that level. In order to keep sloshing water from causing the pump to turn on and off repeatedly, there is a time delay built into the automatic sensor. Water must be in contact with the sensor for 15-20 seconds before the pump is actuated. Likewise, the pump will remain on for 15-20 seconds after water is below the sensor level.

**Note, however, that for this function to be operative, the switch must be in the "on" position. This will NOT drain significant power from your battery unless the bilge pump is called upon to run frequently because of a leak or rainwater accumulation. The automatic system should not be relied upon over an extended period of time. We suggest you frequently inspect your boat.**

**PUMP/MAN:** This switch operates the bilge pump without benefit of any automatic devices. Simply push it in to engage. **NOTE:** DO NOT run the bilge pump dry for extended periods of time.

**NAV LTS:** This controls your navigational lights. The law requires that while running, after sunset and before dawn, the combination side lights (located at the bow) and the 360 degree all around-light (located at the stern) be operating.

**ANCHOR:** This switch activates only the 360 degree all around light. It is called the "anchor light" and is required by law to be shown whenever the boat is in navigable waterways but not underway, after sunset and before dawn.

**ACCESSORIES:** If you have additional components installed on your boat, such as a cigarette lighter, searchlight, compass light, depth flasher and the like, they may be controlled by these switches.

**NOTE:** SUCH ACCESSORIES SHOULD BE INSTALLED AND WIRED BY SOMEONE KNOWLEDGEABLE IN MARINE WIRING.

**IGNITION:** This switch activates the blower and MUST ALWAYS BE ENGAGED FOR AT LEAST FOUR (4) MINUTES BEFORE STARTING THE ENGINE. THIS PROCEDURE IS MENTIONED ELSEWHERE IN THIS MANUAL AND MUST BE FOLLOWED FOR THE SAFE OPERATION OF YOUR BOAT.

**CLOCK:** The clock operates ONLY when the ignition push button switch is in the "ON" position (pushed in). To reset, simply push in the reset knob on the clockface and turn to the desired time.

**12-VOLT RECEPTACLE:** A 12-volt receptacle for operating accessories is located on the side of your Nautique dash pod.

## YOUR BOAT

**ENGINE WARNING LIGHT:** Located at the center of the dash pod, this light indicates high temperature or low oil pressure. It is an early warning indicator reflecting engine difficulty.

**HORN:** This is a momentary rocker switch. (It returns to the "OFF" position when you release it.) Just press the high side to activate.

**VOLT:** The voltmeter tells you when the charging system is functioning correctly. Refer to your engine manual for specific operating range.

**TEMPERATURE GAUGE:** This gauge lets you know if your engine is running outside the normal range. It reads in both Fahrenheit and Celsius. Consult your engine manual for the allowable limits.

**OIL PRESSURE GAUGE:** This gauge tells you the status of the engine oil pressure and is stated in both PSI (pounds per square inch) and metric measure. Consult your engine manual for the proper reading. **NOTE: WITHOUT OIL PRESSURE IN THE ENGINE, THE MOVING PARTS WILL NOT BE LUBRICATED WHICH WILL LEAD TO SEVERE ENGINE DAMAGE.**

**FUEL GAUGE:** This gauge provides an estimate of the amount of fuel in the tank.

**HOUR METER:** This instrument records the hours THAT THE IGNITION SWITCH IS ENGAGED.

**TACHOMETER:** Your tachometer will show the revolutions per minute (RPM) of the engine under any given throttle setting from idle to full speed. The numbers shown on this gauge are multiplied by a factor of one hundred. (Thus, 30 on your gauge translates to 3000 RPM.)

**EMERGENCY SHUT-OFF SWITCH:** This switch is to be attached to the driver and helm connection at all times while boat is running. Before getting underway, conduct a check of this system by attaching the lanyard to the post at the helm, starting the boat, and then pulling the lanyard free. The boat engine should stop. Under no circumstances should you operate the boat if this system is not functioning properly.



## YOUR BOAT

**SPEEDOMETERS:** There are two speedometers mounted on the dashboard of your boat. They are calibrated by Correct Craft at 36 mph. They can be adjusted by turning the knob at the bottom of the face of the speedometer. The speedometers are two wholly **separate** systems. One is a back-up in the event that the other becomes obstructed. (Consistent speed is critical to the tournament skier.)

On each side of the transom below the water line, you will find a tube with a fitting and a rubber hose leading from it. This is called a "pitot tube," "impact tube" or "pick-up tube." Let's call it a "pick-up" tube for the sake of discussion. The pick-up tube allows a small amount of water to be driven to a certain point in the system as the boat moves forward. That point in the system is called a "stabilizer tube." It is a vertically mounted brass tube at the stern. (You can't see this tube since it is mounted behind the gas tank.)

What happens is that the water in this tube compresses the air in the hose connecting to the instruments and it becomes, literally, a pressure gauge. **(Remember, there are two separate speedometer systems in your boat.)**

**NOTE:** When trailering your boat, it is a good idea to place your pick-up tubes in the stored position, that is, turned to the side. This is recommended to avoid collection of road debris such as mud, oils and any other matter than can become lodged in the tube, thus adversely effecting the efficiency of your unit. To achieve this, press down firmly at the end of the tube (it is spring-loaded) and turn upward in either direction.

## YOUR BOAT

**TROUBLESHOOTING YOUR SPEEDOMETER:** The most common cause of an improperly functioning speedometer is water borne debris such as grass, weeds, sand or mud lodged in the pick-up tube. The speedometer may fail to register or it may hover at a particular speed while the boat is at rest. This indicates a pick-up tube obstruction.

In many cases the obstruction can be dislodged by backing up quickly. If that fails, use air pressure to clear the tube. Reaching under the dash, remove the rubber tubing from the back of the speedometer and apply air pressure with a volleyball pump or other air pressure source. **Do not exceed 25 p.s.i.** If this method fails to dislodge the obstruction, trailer your boat and remove the hose at the transom. Using a needle, remove the obstruction. For stubborn pieces, remove the brass cap on the end (using needle nose pliers) and clear the tube. Re-install the brass cap.

If the speedometer reacts slowly, a leak in the system may be the cause. Most frequently, the leak is located at the connection of the tubing to the speedometer head, again under the dash. Disconnect this tube and apply air pressure with a volleyball pump or other controlled source, not exceeding 25 p.s.i. Blow air through the tube until the water is expelled. Attach the tube to the back of the speedometer head, making certain that the connection is air tight. If the tube end is stretched or over-sized, trim off 1/2-inch and reconnect. **Note: Some Correct Craft models have a locking nut at the back of the speedometer. This nut must be loosened to disconnect the hose.**

Damage can occur if a malfunction is not immediately attended. If you cannot remedy the situation, contact a Correct Craft dealer or another reputable marine mechanic.

**WINTERIZING YOUR SPEEDOMETER:** As a precaution, due to season freezing temperatures, winterize your speedometer by removing all water from the stabilizer tube to eliminate the danger of damaging the system. Disconnect the tube at the connection to the speedometer under the dash and apply air pressure through the system. Introduce enough air to clear the system, but do not exceed 25 p.s.i.

## YOUR BOAT

**STEREO:** Your boat comes equipped with a stereo and marine speakers. Refer to your stereo owner's manual for operating and/or warranty instructions.

**STARTING YOUR ENGINE:** The blower should be operated with the engine cover open for at least four minutes before attempting to start the engine.

**IGNITION SWITCH:** The ignition switch on the left **MUST** be pushed in to the "ON" position before your engine can be key-started. The key-start switch is directly to the left of the horn bottom. It has three positions. Vertical position of the key slot is "OFF" a 45 degree angle of the slot is "ON;" and the 90 degree position (horizontal) is the "START" position. (It is very similar to a car.)

## YOUR BOAT

**THROTTLE CONTROL WITH LOCK OUT:** The throttle control consists of a throttle lever, lock out ring and neutral throttle button. (See picture for locations.) The neutral throttle button is a push-pull button that, in the "OUT" position, locks the transmission in neutral. You should have this button out while starting. This will help to warm up the engine and will ensure against inadvertent transmission engagement.



The lock out mechanism prevents unintentional shifting into forward or reverse, while the neutral throttle button is pushed in. (Straight up is neutral, to the bow is forward and toward the stern is reverse.)

For starting or warm-up place the throttle control lever in the neutral position and pull out the neutral throttle button. This disengages the shift mechanism. The throttle lever can then be moved forward or backward to advance the throttle, but ONLY by lifting the lock out ring. When warm-up is completed, return the lever to neutral, push in the button and the control is ready for single lever operation.

To operate the throttle control lever, you must lift the lock out ring to move the throttle lever into forward or reverse. DO NOT shift too quickly from forward into reverse. Stay in the neutral or idle position until the boat has lost speed before completing the shift to reverse. Unless in an emergency, shifting should not be attempted above 1200 RPM. For further information for specifics of the throttle mechanism, consult the manufacturer's pamphlet that's supplied with your boat.

**CAUTION:** To ensure safe boating practice, the loading and unloading of passengers, whether it be from a dock or from the water, should only be attempted after both the ignition and the engine have been turned off.

**NOTE:** Before you start your engine, be sure to follow the recommendations in regard for fuel leaks, excessive water in the bilge, blower operation (at least four minutes with the motor cover up) and your engine's water strainer. These are important operations which take very little time.

## YOUR BOAT

### INTERIOR FEATURES AND FITTINGS

**TOW PYLON:** Your tow pylon is manufactured of a superior aluminum alloy that is engineered for durability. It is hard coat anodized and layered with a PTFE (teflon) material. Little maintenance is required.

It is mounted in such a way as to become an integral part of the hull. If any tow pylon looseness develops, stop tow pylon use and take your boat to your Correct Craft dealer to solve the problem(s).

**CAUTION:** Avoid personal injury. This water ski tow pylon was designed for water skiing only. Any other uses, such as parasailing, kite flying, towing other boats, etc. may overstress the pylon possibly causing personal injury and/or equipment damage. DO NOT sit behind (aft) the tow pylon when towing a skier(s).

**CAUTION:** ALTHOUGH THE BAREFOOT BOOM HAS BECOME A POPULAR ADDITION TO MOST TOURNAMENT INBOARDS, CORRECT CRAFT DOES NOT RECOMMEND INSTALLING A BOOM ON ANY CORRECT CRAFT BOATS. AND FURTHER, CORRECT CRAFT WILL NOT ASSUME RESPONSIBILITY FOR DAMAGE OR PERSONAL INJURY THAT MAY OCCUR FROM THE USE OF BOOMS ON CORRECT CRAFT BOATS.

## YOUR BOAT

**LIFTING RINGS:** Your Nautique is equipped with bow and stern lifting rings. They are designed to lift your boat in a steady, secure position. Use a winch that has a lifting capacity sufficient to lift your boat. See the weight specifications for your boat on Page 1 of "Your Boat." (DON'T FORGET TO ALLOW FOR THE WEIGHT OF FUEL AND GEAR.)

**CAUTION:** Drain the bilge to eliminate excess water prior to lifting your boat. (Under this condition the lifting stability and the stress exerted on the lifting rings are greatly effected.)

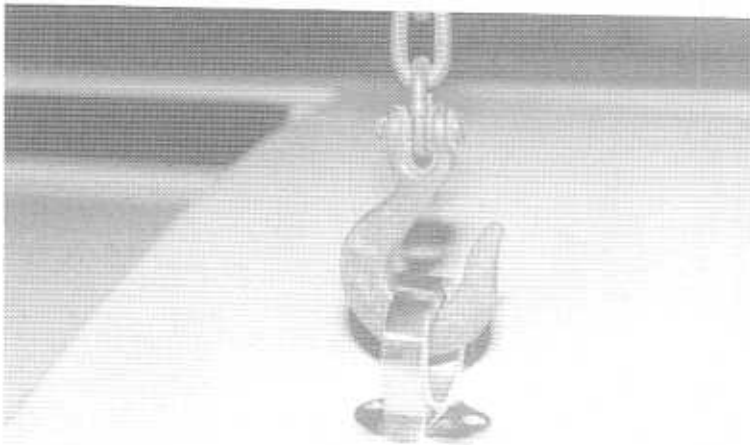

Proper Hook Size

**NOTE:** Use a hook that will pass easily through the ring without binding. This is VERY important. A hook that is too large or off-center could snap the ring. (See illustration)

The lifting rings on your boat are more than sufficient to accommodate its weight. Care must be taken to ensure proper hook-up. Consult a professional for proper design of hardware (hooks, yorks, slings, cable diameter, spreader bar, etc.).

## YOUR BOAT

**WATER STRAINER:** The water strainer, or filter, is an in-line system. **The Sherwood Line Strainer** has an inlet and an outlet side for the efficient transfer of cooling water through your engine while running. (See illustration for location.) **It is extremely important to visually check this filter before each use of boat.** This can be accomplished during the recommended **four minute period while your blower is running and the engine cover is up.**

There is a fine wire screen inside the bowl on the bottom of this unit which collects grass and debris. It is designed to remove debris before it reaches the engine.

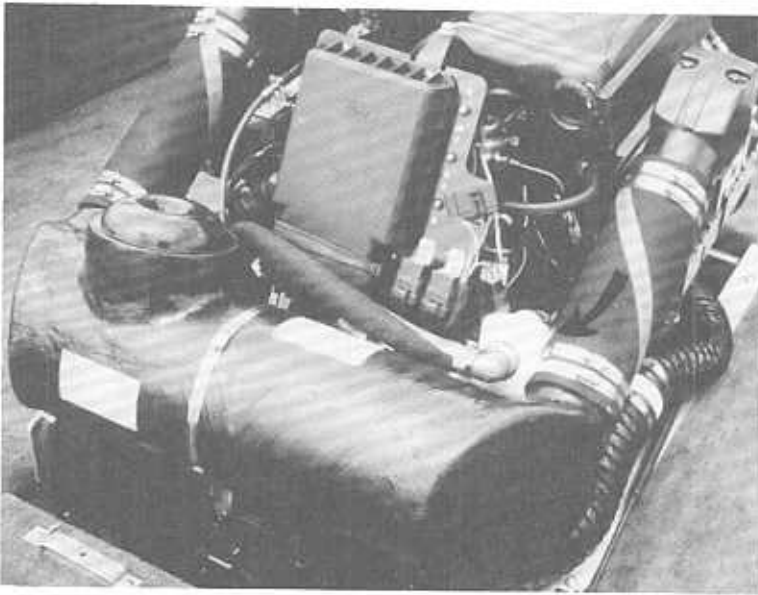

Strainer Assembly

If you see debris, unscrew the bowl from the cap. **Be careful not to lose the O-ring.** Lift out the wire screen. Flush the sediment from the screen AND bowl with water. Replace the screen, inserting the O-ring gasket and re-install the bowl. Turn the bowl **HAND** tight. **DO NOT** over-tighten.

**IMPORTANT:** This should be done prior to every use of your boat. Debris can restrict the normal flow of cooling water to your engine, causing over-heating.

**The Sherwood filter bowl remains full of water even when the raw water system has been drained. To properly winterize the boat, the filter bowl should be removed and emptied.**

If the water is not removed, the bowl could be subject to freeze damage, which could result in over-heating during the next season.

It is recommended that you review the manufacturer's literature regarding this unit.

## YOUR BOAT

IT IS RECOMMENDED THAT YOU LOOK OVER THE MANUFACTURER'S LITERATURE REGARDING THIS UNIT.

**NOTE:** THIS IS A VERY IMPORTANT PREVENTIVE MAINTENANCE FUNCTION AND, WE REPEAT, SHOULD BE DONE AT **EACH USE OF YOUR BOAT**. DEBRIS CAN COLLECT TO THE POINT THAT IT RESTRICTS THE NORMAL FLOW OF COOLING WATER TO YOUR ENGINE, CAUSING OVER-HEATING.

TAKE THE SHORT TIME REQUIRED TO CHECK THIS **VERY IMPORTANT** FILTER TO ENSURE THAT IT IS CLEAN. IF IT IS NOT, SIMPLY RINSE OUT THE FILTER AND REASSEMBLE AS STATED ABOVE.

You should also periodically check the opening to the transmission oil cooler. Just remove the hose by loosening the clamp and pulling off the hose with a twisting motion. Looking down into this opening, you will observe a honey-comb-like filter (see photograph). If you see any grass or debris on the filter, simply remove it. (A pair of needle-nose pliers is ideal for this purpose.)

## **PROLONGED STORAGE**

Should you need to store your boat for an extended period of time, we suggest you introduce a fuel stabilizer such as STA-BIL to prevent the formation of gum and varnish.

Add the recommended amount to the fuel and run the engine for a minimum of ten minutes, allowing the mixture to enter the carburetor. Subsequent starts the following season should be trouble free. Refer to the orange pamphlet in the back of this manual, or call toll-free, 1-800-FOR EAGLE, for more information.

### Transmission Cooler



**TRANSMISSION COOLER:** Periodically check the transmission oil cooler opening. Loose the clamp and twist the hose to remove it. Inspect the honeycomb-like filter for debris. Remove the debris, using a pair of needle nose pliers before re-installing the hose.



## YOUR BOAT

**TRANSOM:** Your new Nautique transom features a Euro-styled boarding platform. The boarding platform lends a sleek look to the Nautique and it is supremely functional and easily removable. This unique feature is standard equipment and its sole purpose is to facilitate the craft's storage. **THIS IS THE ONLY TIME THIS PLATFORM SHOULD BE REMOVED.**

**BOARDING PLATFORM:** Should you need to remove the platform for storage of your boat, simply remove the two locking pins located at the bottom of the boarding platform brackets. Next, lift the platform upward. The platform socket will slide upward from the transom post. We suggest you store the platform with the boat so it will not be forgotten on your next outing. **NEVER use your Nautique without the boarding platform properly in place.**

Because of the proximity of the stern seat to the exhaust port, the boarding platform is instrumental in channeling engine exhaust gases, which include carbon monoxide, away from the stern. Failure to have the platform properly installed could result in excessive carbon monoxide levels in the boat. **EXCESSIVE CARBON MONOXIDE LEVELS CAN CAUSE INJURY OR DEATH. NEVER OPERATE THIS CRAFT WITHOUT THIS SPECIALLY DESIGNED PLATFORM IN PLACE.**

<p><b>DANGER!</b></p> <p>PERSONAL CONTACT WITH A SPINNING PROPELLER CAN CAUSE INJURY OR DEATH. SHUT OFF ENGINE IF PERSONS ARE:</p> <ul style="list-style-type: none"><li>• GETTING IN OR OUT OF BOAT</li><li>• ON BOARDING PLATFORM</li><li>• NEAR PROPELLER</li></ul> <p>SEE OWNER'S MANUAL FOR ADDITIONAL INFORMATION</p>	<p><b>DANGER!</b></p> <p>CARBON MONOXIDE IS POISONOUS. EXCESSIVE EXPOSURE MAY CAUSE INJURY OR DEATH. OPERATE THIS BOAT ONLY WITH A CORRECT CRAFT INC. BOARDING PLATFORM SECURED IN PLACE OR EXCESSIVE CARBON MONOXIDE EXPOSURE MAY OCCUR.</p>
---	---

### Dash Warning

<p><b>DANGER!</b></p> <p>PERSONAL CONTACT WITH A SPINNING PROPELLER CAN CAUSE INJURY OR DEATH. SHUT OFF ENGINE IF PERSONS ARE:</p> <ul style="list-style-type: none"><li>• GETTING IN OR OUT OF BOAT</li><li>• ON BOARDING PLATFORM</li><li>• NEAR PROPELLER</li></ul> <p>SEE OWNER'S MANUAL FOR ADDITIONAL INFORMATION</p>	<p><b>WARNING</b> ⚠</p> <p>AVOID PERSONAL INJURY. THIS WATER SKI TRANSOM TOW RING WAS DESIGNED FOR WATER SKIING ONLY. ANY OTHER USES SUCH AS PARASAILING, KITE FLYING, TOWING OTHER BOATS, ETC. MAY OVERSTRESS THE TRANSOM TOW RING POSSIBLY CAUSING PERSONAL INJURY AND/OR EQUIPMENT DAMAGE.</p> <p>DO NOT TOW MORE THAN TWO WATER SKIERS WITH THIS TRANSOM TOW RING.</p>	<p><b>DANGER!</b></p> <p>CARBON MONOXIDE IS POISONOUS. EXCESSIVE EXPOSURE MAY CAUSE INJURY OR DEATH. OPERATE THIS BOAT ONLY WITH A CORRECT CRAFT INC. BOARDING PLATFORM SECURED IN PLACE OR EXCESSIVE CARBON MONOXIDE EXPOSURE MAY OCCUR.</p>
---	--	---

### Transom Warning

**WALK-THROUGH WINDSHIELD:** Should you have a walk-through windshield installed after the boat leaves the Correct Craft factory, be certain to have bow and deck non-skid material applied to reduce the chance of slipping on the surface.

## YOUR BOAT

**FUEL FILL:** Located on the aft deck is the fuel fill. The cap is removed by a key found in the informational packet supplied with your boat. Keep this key in a handy location so that it does not become misplaced.

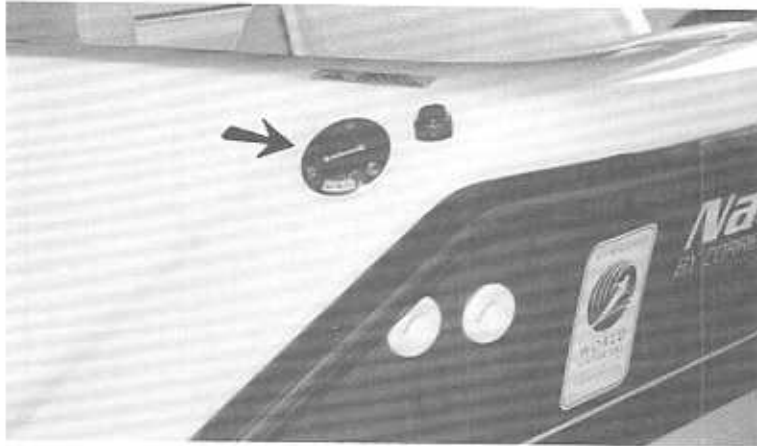

Fuel Fill

**CAUTION:** Extinguish any ignited material (cigarettes, pipes or cigars) while re-fueling your boat.

**NOTE:** After re-fueling and before starting your engine, run your blower for a minimum of four minutes with the motor cover up.

**STERN COMPARTMENT:** To gain access to this compartment, simply pull down on the fabric loop at the top of the covering panel while pulling out on one of the bottom loops. (See illustration.) The stern compartment is now exposed.



**NOTE:** Should your boat be equipped with the optional deluxe seating, you will have to remove the rear seat. Note that the gasoline tank occupies most of the space here and that the two stern vent hoses are visible just above the tank. Also note the fuel system on the top of the tank, the boat transom and the aft deck. **IT IS RECOMMENDED THAT YOU CHECK THESE FITTINGS PERIODICALLY FOR ANY GASOLINE LEAKAGE.**

**BILGE PUMP WITH AUTOMATIC SWITCH:** The Ski Nautique's bilge pump is located beneath the motor box behind the ski pylon. The Ski Nautique Open Bow is equipped with an additional bilge pump located in the rudder area of the transom.

**DRAIN PLUG:** Drain the water from the bilge after every use. To remove the drain plug, lift the motor box. The T-handle drain plug is located just behind the ski pylon.

Accessing Stern Compartment

## YOUR BOAT

**STORAGE COMPARTMENTS:** Correct Craft strives to design dry storage compartments. However, due to varying environmental conditions, equipment and other items, damageable by water or mildew, should not be left in the compartments for long periods of time. If the storage compartments are damp or wet, they should be left open in a covered area to dry.

### **GULL-WING OBSERVER SEAT:**



This seat is engineered to give you total access to the bow storage area. To gain access to this area, raise the hinged seat. It is held upright by a convenient gas spring.

**CAUTION:** Avoid personal injury. **DO NOT** sit on the cut-out section of the side deck of your boat. It is not a seat. It was designed to assist in loading and off-loading passengers.

**DRIVER SEAT:** There is an adjustment lever under the seat on the inboard side to control fore and aft positioning.

## YOUR BOAT

### **STERN SEAT STORAGE:**

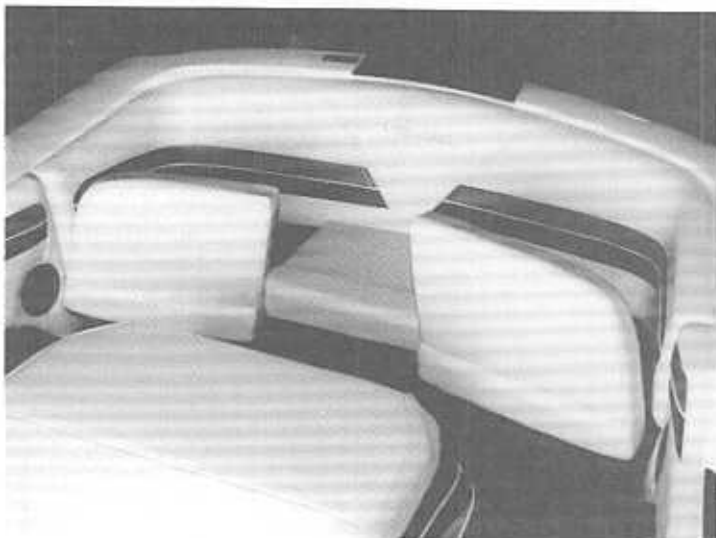

Stern Seat Storage

If your boat is equipped with the deluxe stern seat, you have additional storage areas available. Its three compartments can be accessed independently for small gear storage.

To create a convenient step to the platform, unsnap and remove the center cushion of the seat and store it in the compartment below.

### **BATTERY COMPARTMENT:**

The battery compartment is located in the floor beneath the gull-wing observer seat.

**NOTE:** SEE "BATTERY" UNDER "OPERATIONAL MAINTENANCE" FOR THE PROPER CARE OF YOUR BATTERY.

**HORN:** Your horn is mounted behind the bow vents and should be considered a dealer-serviced item should it cease to function properly.



**STERN LIGHT:** Your stern light or "Anchor Light" is required by law to be used while running after sunset and before dawn in conjunction with your combination side lights. It can be solely used as an anchor light while not under power. It is stored under the port gunwale.

(A nib on the shaft mates with a keyway in the receptacle for alignment of electrical contacts.)

## TRAILER

Your Correct Craft trailer is designed to cradle your boat securely and with a minimum of pressure exerted against the hull under highway and/or launching and recovery conditions. You can't be too good to the hull of your boat, so proper cradling in transit or storage is essential.

**SEALED BEARING SYSTEM:** Your trailer wheel hubs are equipped with a posi-lube system that helps to seal the bearings against the intrusion of water and dirt. This is especially important since your trailer is the drive-on type so the wheels are submersed while launching and recovering. Additionally, the cooling effect of water can cause debris to be sucked into an unprotected hub causing rapid deterioration and bearing failure.

With the posi-lube system, complete lubrication is achieved by a lubricating hole drilled through the center of the spindle to a perpendicular hole between the rear seal and the rear bearing. To lubricate the posi-lube spindle, you simply remove the rubber plug, install a standard grease gun and apply grease. The grease flows through the lubricating hole to the rear seal area and toward the front of the assembly (see illustration). Sufficient lubrication is present when grease begins to flow out of the metal end cap. This action is indicated in the illustration and grease flow is indicated by arrows.

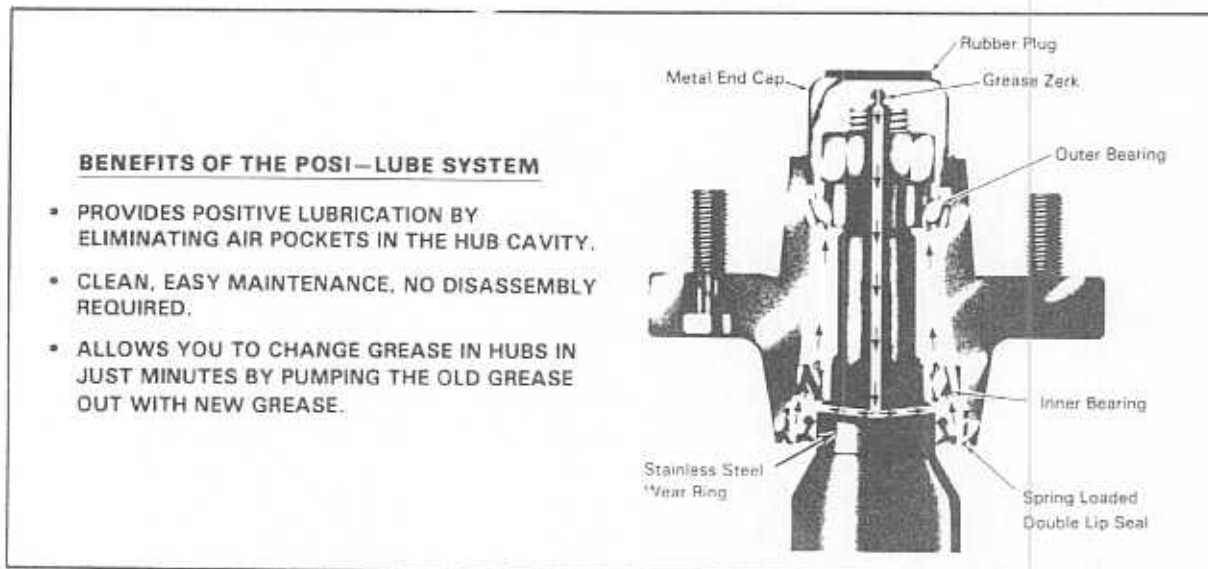

If you need to change the grease in your hub, simply pump in new grease and watch until all old grease is purged. Stop when new grease begins to exit the metal end cap.

**CAUTION:** If the wheel bearing spindle nut is removed for any reason, be sure to replace the bendable tab lock washer with a new one. Failure to put on a new lock washer could result in loosening of the spindle nut.

## TRAILER

**TURNBUCKLE:** Your trailer comes equipped with a galvanized turnbuckle (see illustration below). This turnbuckle is to be used while trailering your boat and must be removed for the launch and recovery of your boat. There is a wing-nut located on the top of the turning mechanism that secures your turnbuckle once it has been affixed to the bow eye of your boat. You must loosen this wing-nut before you can loosen the turnbuckle.

<b>CAUTION</b> 	<b>TO AVOID EQUIPMENT DAMAGE, NEVER TOW YOUR BOAT AND TRAILER UNLESS TURNBUCKLE IS ATTACHED TO BOTH. DRIVE BOAT ON TRAILER, ATTACH TURNBUCKLE TO BOAT AND TRAILER BEFORE PULLING FROM WATER. DO NOT TIGHTEN TURNBUCKLE UNTIL THE BOAT IS CLEAR OF THE WATER.</b>
---	--

Turn the body of the turnbuckle only by hand. Once all of the slack is removed from the turnbuckle, tighten the wing-nut.

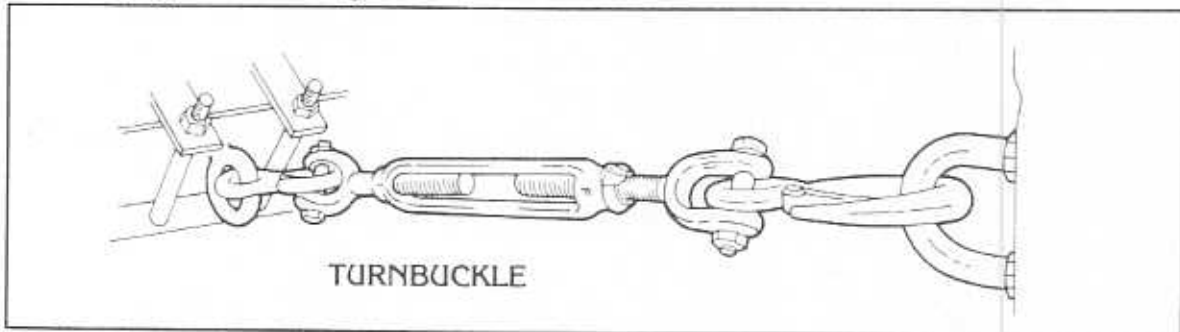

**DOLLY JACK:** The dolly jack mounted toward the front of your trailer affords an easy method of storing your boat in a raised position and also in raising and lowering the trailer in respect to your vehicle's hitch. **TO AVOID PERSONAL INJURY AND EQUIPMENT DAMAGE, NEVER PLACE HANDS OR OTHER BODY PARTS BETWEEN THE COUPLING AND ANY PART OF THE TOW VEHICLE.**

The dolly jack should be periodically oiled for smooth operation. Introduce some light lubricating oil into the hole located just below the jack crank handle on the left hand side of the jack post. This can be done with a small oil can.

Some Correct Craft trailers feature a "swing up" dolly jack. Once the trailer is coupled to the tow vehicle, turn the crank handle until the weight is off the dolly jack. Then pull the spring loaded pin out, swing the dolly jack parallel to the ground and reinsert the pin. This convenient feature saves time by eliminating the need to crank the jack the full scope up or down.

## **TRAILER**

**BOW STOP ASSEMBLY:** Your trailer is equipped with a bow stop so that when the boat's bow is snug against the two vertical boards, the proper weight exerted upon the trailer tongue is maintained.

**SAFETY CHAINS:** Just behind the hitch coupler, you will find a chain looped through a metal brace on the bottom of the trailer tongue that should be crossed under the tongue and secured to the towing vehicle's trailer hitch. (On most trailer hitches, you will find provision for this.) See photograph below for proper hook-up.

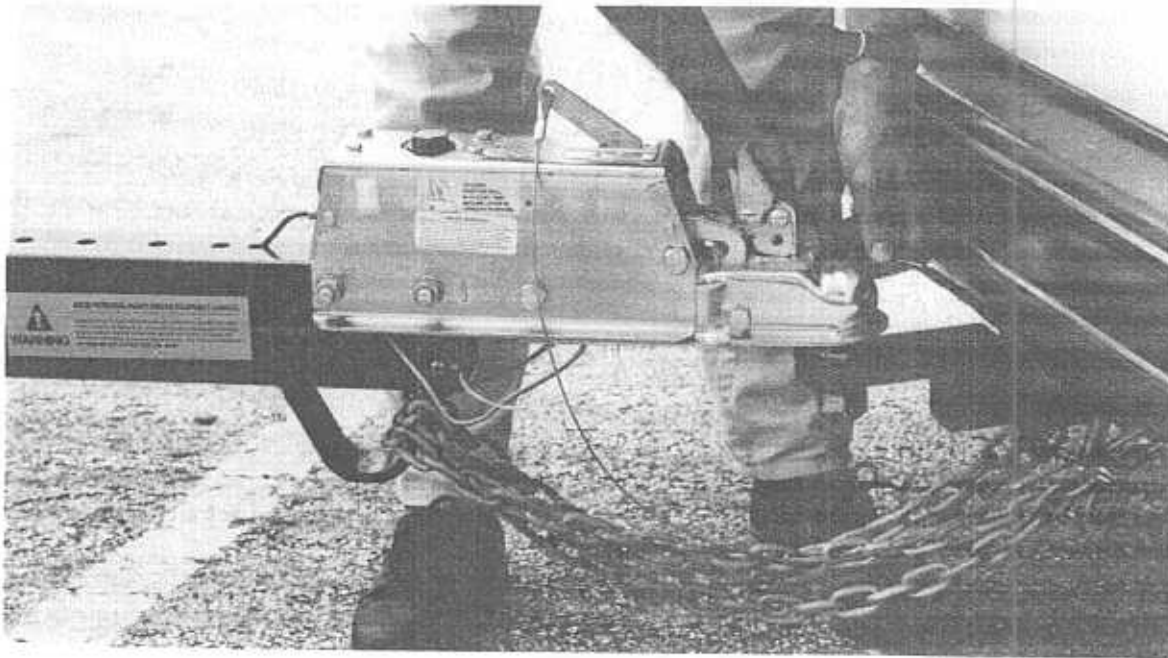

**THIS CONNECTION IS A REQUIREMENT IN MOST STATES WHILE PULLING A TRAILER OF ANY TYPE. YOU SHOULD CHECK YOUR OWN AREA'S REGULATIONS REGARDING TRAILERING.**

Be sure that there is sufficient slack in the chain to allow sharp cornering without binding. Insufficient slack can cause damage and make cornering difficult.

**NOTE:** For proper towing characteristics the National Marine Manufacturers Association (NMMA) recommends that the trailer tongue weight exerted on the rear of the towing vehicle be no less than five percent (5%) and no more than 10 percent (10%) of the total weight of boat, trailer, fuel and gear on board. Incorrect tongue weight can cause improper and potentially hazardous towing conditions. To determine the appropriate tongue weight for your Correct Craft boat and trailer, please refer to the table and formula on the page titled **Proper Trailer Tongue Weight** in this chapter.

**10**

## TRAILER

**HITCH:** If you don't already have a trailer hitch installed on your vehicle, you should go to a reputable installer to have this done. Correct Craft trailers require a 2" hitch ball of proper capacity for your boat/trailer combination.

(It is also a good idea to purchase an inexpensive hitch ball protective cover available at marine supply stores.)

**WARNING: DO NOT ATTEMPT TO TOW MORE THAN ONE TRAILER AT A TIME BEHIND YOUR TOW VEHICLE.** Your Correct Craft trailer was designed to accommodate the weight of a specific boat under normal load. By attempting to tow an additional trailer, the trailer tongue weight is adversely effected and loss of vehicle control and/or injury or death may occur.

**CAUTION: NEVER INSTALL A BUMPER-MOUNTED HITCH ON YOUR VEHICLE. ALWAYS USE A HITCH ATTACHED TO THE FRAME OF YOUR VEHICLE.**

Always use a hitch rated with the appropriate capacity to match the trailer's gross vehicular rating (see caution label on trailer and Proper Trailer Tongue Weight pages in this chapter.)

**WIRING:** Unless you are an expert in towed vehicle wiring, have your vehicle wired to the requirements of your trailer by someone familiar with such work. (Most reputable firms can supply this service at the same time that your hitch is installed.)

**SECURITY:** There are several locking devices available at marine supply stores that will aid in securing your boat whether or not it is attached to your vehicle.

**TILT TONGUE:** Some Correct Craft trailers are equipped with a tilting tongue to facilitate storage. To tilt the trailer tongue, remove the 5/8" bolt from the trailer tongue. Tilt the tongue down, pulling the loading pads away from the bow. Remove the pin from the base of the front loader and loosen pinch bolt. Lift up and remove the front loader. The trailer tongue can then be tilted up to shorten the overall length of the trailer. On Ski Nautique trailers, the turnbuckle can be fastened through the tie down ring on the starboard side of the folded piece to keep the tilted tongue from falling down.

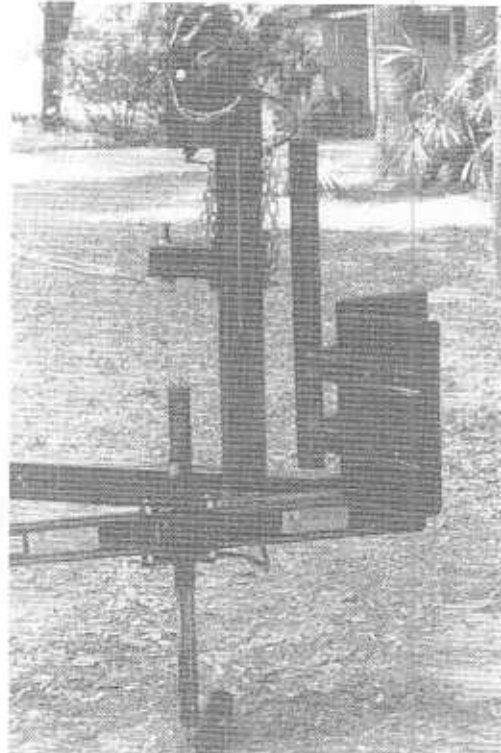



## **TRAILER**

**CARE OF YOUR TRAILER:** Like a car, a trailer consists of painted metal, therefore you should exercise the same kind of care. Frequent washing with a gentle detergent and water and waxing when needed will maintain its lustre. Since the trailer is frequently submersed, you should periodically check for rust spots that may appear. Touch them up promptly with a good rust-preventive touch-up paint, particularly around the wheel hub.

It is a good practice to rinse your boat and trailer with fresh water after each use to remove salt or other contaminants harmful to finishes.

**TOWING YOUR BOAT:** Consult this checklist prior to trailering your boat.

- Check wheel lug nuts for tightness. (Proper torque is 90 to 95 ft. lbs.)
- Check all nuts, bolts and fasteners for tightness.
- Be sure that the coupler is securely fastened and that the safety chains are secured to the vehicle.
- Check the turnbuckle. Make sure it is secure.
- Be sure that the trailer electrical connector is securely positioned with slack allowed for cornering. Check brake lights, turn signals, emergency flasher and running lights with the vehicle engine on and with it off.
- Be sure that the contents and seat cushions in your boat are securely stored, so that no loose gear can fly out of the boat or shift, causing damage to boat or equipment. These items should be stowed carefully or firmly secured.
- **If your Nautique is equipped with a walk-through windshield, make certain the door is in place and closed while the boat is being trailered.**

**NOTE:** Trailer-towed boats are not designed to be used to carry exceptionally heavy loads. This can adversely effect the proper balance of the boat/trailer combination and cause tire failure and/or loss of control.

- Your trailer is equipped with surge brakes. Check the brake operation. (Refer to the brake manufacturer owner's manual for proper instruction.)
- If your boat is equipped with an optional bow winch, make sure that it is snug.
- If your boat is equipped with removable boarding platform, make sure the platform bracket pins are in place before trailering.

**CARPET:** The longitudinal supports that cradle the hull and the bow stop boards are covered with carpeting material. Soap, water and a soft scrub brush are needed to clean this carpet. DO NOT use any caustic substances, as these will deteriorate the carpet on the trailer.

## TRAILER

**DURING TRAVEL:** Each time you stop on a long trip, make these inspections:

1. Recheck the tightness of the wheel lugs and the bearing lubricant level.
2. Recheck the sealed bearings for lubricant level.
3. Ensure that the boat is still positioned snugly against the bow stops.
4. Examine the hitch connection to be sure it is firmly attached and that the safety chains are securely fastened.
5. Make sure that all trailer lights are still functioning properly.
6. Re-examine the contents of your boat to ensure that no items such as life jackets or other gear have become dislodged.

**IMPORTANT!** States have varying laws about trailer tie-downs. Learn what your local and state laws are about trailer tie-downs to determine need for them on your Correct Craft trailer. Beginning August, 1987, tie-downs were equipped standard on all Correct Craft trailers. You are responsible for buying and installing the necessary straps.

**TRAILER FENDERS:** Correct Craft applies a non-skid material to trailer fenders. Whether or not your Correct Craft trailer has this material, please adhere to the following:

**WARNING** AVOID PERSONAL INJURY. TRAILER SURFACES ARE SLIPPERY WHEN WET. USE EXTREME CARE WHEN STEPPING ON THEM.



All Correct Craft trailers are equipped with surge brakes. Tandem axle trailers have surge brakes on both the front and rear axles. Specific information about your surge brake system is provided by the manufacturer and is included in the pocket of the new boat kit binder. Read this material carefully and have your brakes serviced according to the surge brake manufacturer's recommendations.

## TRAILER

**TIRES:** Your tires are of the proper size and rating for your Correct Craft boat. You should note, before use, the tire manufacturer's recommended pressure. It is stated on the tire itself in terms of pounds per square inch (PSI).

**Tire pressure is very important and should be checked before each use. Be sure to check the pressure when the tires have cooled.**

**TRAILER TIRE AND WHEEL CAPACITIES:** Correct Craft trailers are NMMA certified. The rims we use have certain weight capacities, as do the tires. Correct Craft does not recommend alteration with custom rims or tires, as they may not meet capacity requirements. See the list below for these specifications.

### **WHEEL AND TIRE WEIGHT CAPACITIES:**

#### Single Axle Trailers

Tire: . . . . . ST 225 75 R15D  
Tire Inflation: . . . . . 65 p.s.i. for each tire  
Wheel: . . . . . 15" X 6 E-coated  
Capacity: . . . . . 2,330 lbs. for each wheel

#### Tandem Axle Trailers

Tire: . . . . . ST 175 80 R13C  
Tire Inflation: . . . . . 50 p.s.i. for each tire  
Wheel: . . . . . 13 X 6 E-coated  
Capacity: . . . . . 1,315 lbs. for each wheel

**DO NOT OVER- OR UNDER-INFLATE SPECIFIC TIRE PRESSURE.**

**TRAILER BRAKE ADJUSTMENTS:** To adjust brakes on your Correct Craft trailer, raise one trailer wheel at a time. Remove dust clip from adjusting slot at lower part of the back side of the brake assembly. Insert the brake adjusting tool as shown in illustration # 1.

While turning the wheel forward, adjust the brake shoes outwardly by moving the end of a flat head screwdriver as shown in figure # 2 until the wheel does not turn. **When you can no longer turn the wheel, back-off (loosen) the adjustment as follows: Single Axle Trailers -- 10 notches, Tandem Axle Trailers -- 5 notches.**

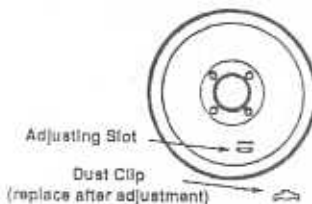

Illustration # 1

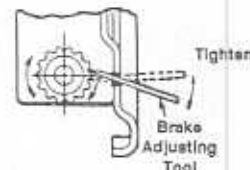

Illustration # 2

**10**

## TRAILER

### APPROXIMATE WEIGHTS FOR CORRECT CRAFT BOATS AND TRAILERS (WITH STANDARD FEATURES).

#### Boats:

- Ski Nautique (closed bow) with 351 cid or Pro Boss engine . . . . . 2340 lbs.
- Ski Nautique (open bow) with 351 cid or Pro Boss engine . . . . . 2475 lbs.
  
- Sport Nautique with 351 cid or Pro Boss engine . . . . . 2700 lbs.
- Nautique Super Sport with Pro Boss engine . . . . . 3000 lbs.

#### Trailers:

- Ski Nautique single . . . . . 1060 lbs.
- Ski Nautique tandem . . . . . 1210 lbs.
  
- Sport Nautique single . . . . . 1060 lbs.
- Sport Nautique tandem . . . . . 1210 lbs.
  
- Nautique Super Sport single . . . . . 1060 lbs.
- Nautique Super Sport tandem . . . . . 1210 lbs.

### APPROXIMATE WEIGHTS FOR BATTERY AND FUEL

- Battery = 45 lbs.
- Fuel = 6.6 lbs. per gallon
- Fuel capacity:
  - Ski Nautique = 26 gallons
  - Sport Nautique = 26 gallons
  - Super Sport = 30 gallons

To calculate weight of fuel in boat, multiply the number of gallons of gasoline in your boat's fuel tank by 6.6. The result will tell you the weight of fuel on board in pounds.

**\*\*\* Gallons of fuel in boat X 6.6 lbs. = Weight of fuel in boat. \*\*\***

## TRAILER

### TO FIGURE PROPER TRAILER TONGUE WEIGHT:

1. Determine the specific weight of fuel on board and the specific weight of personal gear and equipment in the boat.
2. Add these two figures to the weight totals of the boat, trailer and battery.
3. Multiply the total weight of boat, trailer, battery(s), fuel and gear by .05 (5%) to determine the minimum tongue weight recommended.
4. Multiply the total weight of boat, trailer, battery(s), fuel and gear by .10 (10%) to determine the maximum tongue weight recommended.

### EXAMPLE OF FIGURING CORRECT TRAILER TONGUE WEIGHT:

Boat Weight  
+ Trailer Weight  
+ Battery Weight  
+ **Weight of fuel in boat (gallons of fuel X 6.6 lbs.)**  
+ **Weight of personal gear on board**

---

= TOTAL WEIGHT

TOTAL WEIGHT TIMES .05 = MINIMUM TONGUE WEIGHT  
(total weight x .05 = minimum tongue weight)

TOTAL WEIGHT TIMES .10 = MAXIMUM TONGUE WEIGHT  
(total weight x .10 = maximum tongue weight)

**TRAILER TONGUE WEIGHT SHOULD BE BETWEEN THE MINIMUM AND MAXIMUM FOR PROPER TOWING CHARACTERISTICS. THE OPTIMAL TRAILER TONGUE WEIGHT SHOULD NOT BE LESS THAN 5% OF THE TOTAL WEIGHT NOR SHOULD IT BE MORE THAN 10% OF THE TOTAL WEIGHT.**

## **TRAILER**

Your Correct Craft trailer is equipped to meet applicable Federal safety standards. Check your own local and state requirements regarding brakes and additional equipment that may be required.

**CAUTION:** The trailer lugs should be checked on a regular basis on any Correct Craft trailer to make sure that they are not loose or have been tampered with. It is your responsibility to add this to your preventive maintenance checklist prior to boating or trailering your boat.

**LAUNCHING:** Before launching, be sure that the boat drain plug is securely installed. Check the ramp you will use to ensure sufficient depth to launch. The water should be deep enough to cover the top of the trailer fenders. (See illustration.)

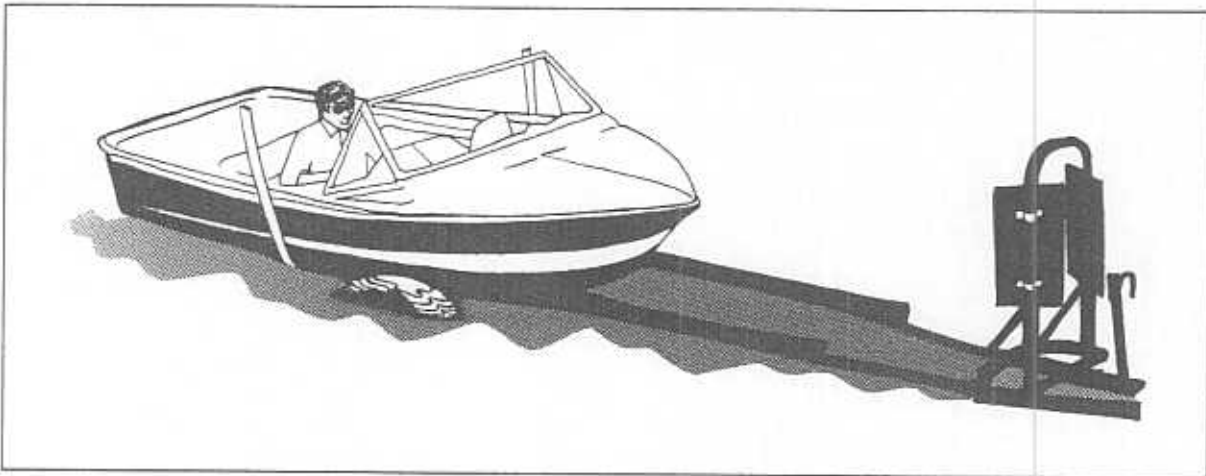

**Do not remove the turnbuckle from trailer or boat boweye until you have fully backed into the water and are ready to drive the boat off the trailer.**

For trouble free launching of a Correct Craft we recommend the following:

1. The trailer should be placed in the water deep enough to float at least half of the boat. This will vary depending on the angle of the ramp, but generally on mid-engine boats, this is with the fenders two to three inches above the surface of the water. V-drives will require the fenders to be deeper because the axle is further back. Don't be alarmed if the fenders must be submerged more, however be careful not to drop the trailer off the end of the ramp.
2. When in this proper position, make sure that the turnbuckle is detached and that there are no other restraints from trailer to boat.
3. Turn the wheel all the way to the right to compensate for propeller torque when backing off. Avoid applying too much throttle when backing off. If the boat sticks hard to the trailer, back the trailer in deeper. Applying too much throttle when backing off causes excessive wear on the trailer carpet and port rub rail.

## TRAILER

**RECOVERY:** Back the trailer until water covers the trailer fenders. With the trailer in this proper position, slowly drive the boat between the two vertical posts and onto the partially submerged trailer. Gently ease the boat until the bow rests between the two bow stops. When the boat is in this correct position on the trailer, attach the turnbuckle on the trailer to the boat boweye. Do this before driving the vehicle and trailer from the ramp. Then turn the turnbuckle to remove any slack.



**CAUTION:** When you are launching or recovering your boat, look around the ramp site carefully for swimmers or pedestrians near the tow vehicle and boat. Always perform a thorough check of both the land and water area. **DO NOT** proceed until everyone is out of the water or clear of the space you will be using for launch or recovery.

### **CAUTION**



NEVER TOW YOUR BOAT WITH THE CANVAS OPTIONS, WHETHER THEY BE SUN TOP, SPRAY HOOD, CLEAR CONNECTOR, OR ANY OTHER CANVAS, ATTACHED TO THE BOAT, DUE TO WEATHER CONDITIONS, IT IS POSSIBLE THAT YOU COULD EXCEED THE STRENGTH OF THE CANVAS IN A SEVERE WIND. ALSO, NEVER TOW YOUR FISH NAUTIQUE WITH THE CENTER CONSOLE TIPPED IN THE FORWARD POSITION. THIS, TOO, WILL STRESS THE CANVAS AREA AND CAUSE POSSIBLE TEARS.

For trailers with the tilt tongue mechanism, please note the following:

### **WARNING**



#### **AVOID PERSONAL INJURY AND/OR EQUIPMENT DAMAGE**

Inspect trailer tongue tilt bolt and nut every three months or 1000 miles. Failure of the bolt or nut could result in equipment damage and/or loss of control of the tow vehicle and trailer. Replace the bolt and nut if they show any signs of wear. The bolt and nut must be replaced with Correct Craft, Inc. parts.

# 10

## CORRECT CRAFT LIMITED WARRANTY

### (Inboard boats and trailers only)

The Correct Craft warranty is backed by a family tradition of boat building experience since 1925.

#### **Lifetime Limited Warranty:**

Correct Craft, Inc. warrants to the original retail purchaser of each new Correct Craft boat that, under normal authorized use, the deck, hull and stringer shall remain free from structural defects for as long as the boat is owned by the original purchaser.

#### **Five (5) Year Transferable Limited warranty:**

In addition to the Lifetime Limited Warranty, Correct Craft offers a Transferable Five Year Limited Warranty covering the deck, hull and stringer system. This policy may be transferred (for a nominal fee) to subsequent purchasers during a period of five (5) years from the date of delivery to the original retail purchaser.

Exception: This five (5) year warranty does not cover the gelcoat nor any other components fastened or applied to the hull or deck. Gelcoat discoloration, blisters or bubbles and cracks are not considered structural defects.

#### **One (1) year non-transferable warranty:**

Correct Craft, Inc. warrants to the original purchaser that each new Correct Craft boat and/or trailer will, under normal authorized use be free of defect in material and workmanship for a period of one (1) year from the date of delivery to the original retail purchaser.

#### **Gelcoat ninety (90) day non-transferable warranty:**

Correct Craft, Inc. further warrants to the original retail purchaser that each new Correct Craft boat will, under normal authorized use, be free of gelcoat defect for a period of ninety (90) days from the date of delivery to original retail purchaser.

#### **Exceptions:**

The five (5) year and one (1) year warranty shall not apply to:

1. Any Correct Craft boat and/or trailer which has been used at any time for commercial or racing purposes, as a demonstrator or in a promotional program, ski school or ski show.
2. Upholstery, vinyl, canvas, windshield, windows or hatches unless defect is noticed at time of delivery and notification is given to Correct Craft, Inc. within 10 days thereof.
3. Underwater gear which includes propeller, propeller shaft, strut, rudder and fins.
4. Gelcoat, chrome plating, anodized or aluminum finishes or colorfastness of finishes.
5. Damage or malfunction of a boat or trailer resulting from improper maintenance, misuse, negligence, improper or inadequate trailering or cradling of your boat.
6. Any boat or trailer addition, modification, defect and/or repair caused by, resulting from or in connection with any party other than Correct Craft, Inc.
7. Engines, parts or accessories, controls, or other products not manufactured by Correct Craft, Inc. which Correct Craft may use or sell in connection with Correct Craft boats and/or trailers. To the extent that these parts are warranted, purchaser must look to the manufacturer warrantor thereof for such warranty and remedy thereunder for defects in materials or workmanship.
8. **Any and all consequential damages including, but not limited to, costs incurred for haul-out, launching, towing and storage charges, telephone or rental charges of any type, inconveniences, or loss of time or income.**
9. **Any and all gelcoat/hull damage caused by use of a non-Correct Craft produced trailer.**

Any defect or damage covered by this warranty shall be, at the discretion of Correct Craft, Inc., repaired or replaced free of charge at an authorized local dealership, regional warehouse or the Correct Craft factory. Repairs and/or replacements will be warranted only for the remainder of the original warranty period. **Transportation and/or labor to and from the point of repair will be the responsibility of the owner.**

**There are no warranties which extend beyond the description of the face hereof.** These warranties are expressly made in lieu of all other expressed warranties. Duration of any implied warranty or merchantability or fitness for a particular purpose or otherwise, shall be limited to and coincident to the duration of these expressed warranties. Under no circumstances shall Correct Craft, Inc. be liable to the purchaser or any third party for loss of profits or other direct or indirect costs, losses or consequential damages arising out of or as a result of defects in products hereinabove warranted.

Some states do not allow limitations on how long an implied warranty lasts, so the above limitation may not apply to you. Some states do not allow the exclusion or limitation of incidental or consequential damages, so the above limitation or exclusion may not apply to you. This warranty gives you specific legal rights and you may also have other rights which vary from state to state.

**NOTE:** This warranty is expressly conditioned upon the completion and return of the warranty registration card to Correct Craft, Inc. by the selling dealer within fifteen (15) days of the date of delivery. Although not obligated to, and without creating such an obligation, this will enable us to notify you of any necessary performance or safety modifications to your boat or trailer and to verify ownership in case a warranty claim is filed on your boat or trailer.

#### **PROCEDURE:**

In the event your Correct Craft boat and/or trailer has a claim covered by this warranty, the following procedure shall be followed to secure performance or warranty obligations:

1. Notify the selling dealer within 30 days after the discovery of any claimed defect, or 10 days from the day of delivery in the event of a claimed defect involving upholstery, vinyl, canvas or windshield.
2. You may be required to transport the boat, at your expense, to the selling dealer, nearest Correct Craft warehouse, or Correct Craft, Inc. for their inspection and/or repair.
3. Correct Craft, Inc. reserves the right to require further evaluation and/or information regarding a warranty claim against a boat and/or trailer prior to its repair or replacement as well as direction as to the place of repair.

Correct Craft, Inc. reserves the right to make changes in prices, colors, specifications, equipment, options, materials, hulls, decks and/or discontinue models at any time (without notice) and shall be under no obligation to equip or modify boats and/or trailers built prior to such changes.

Correct Craft, Inc., 6100 S. Orange Ave., Orlando, Florida 32809, 407/855-4141, FAX 407/851-7844, Cable address, CORRCRAFT Effective: 1991 Model Boats, 041191



# PLEASURECRAFT MARINE

## Engine Owners Manual

FOR ALL CHEVROLET AND FORD BASED ENGINES

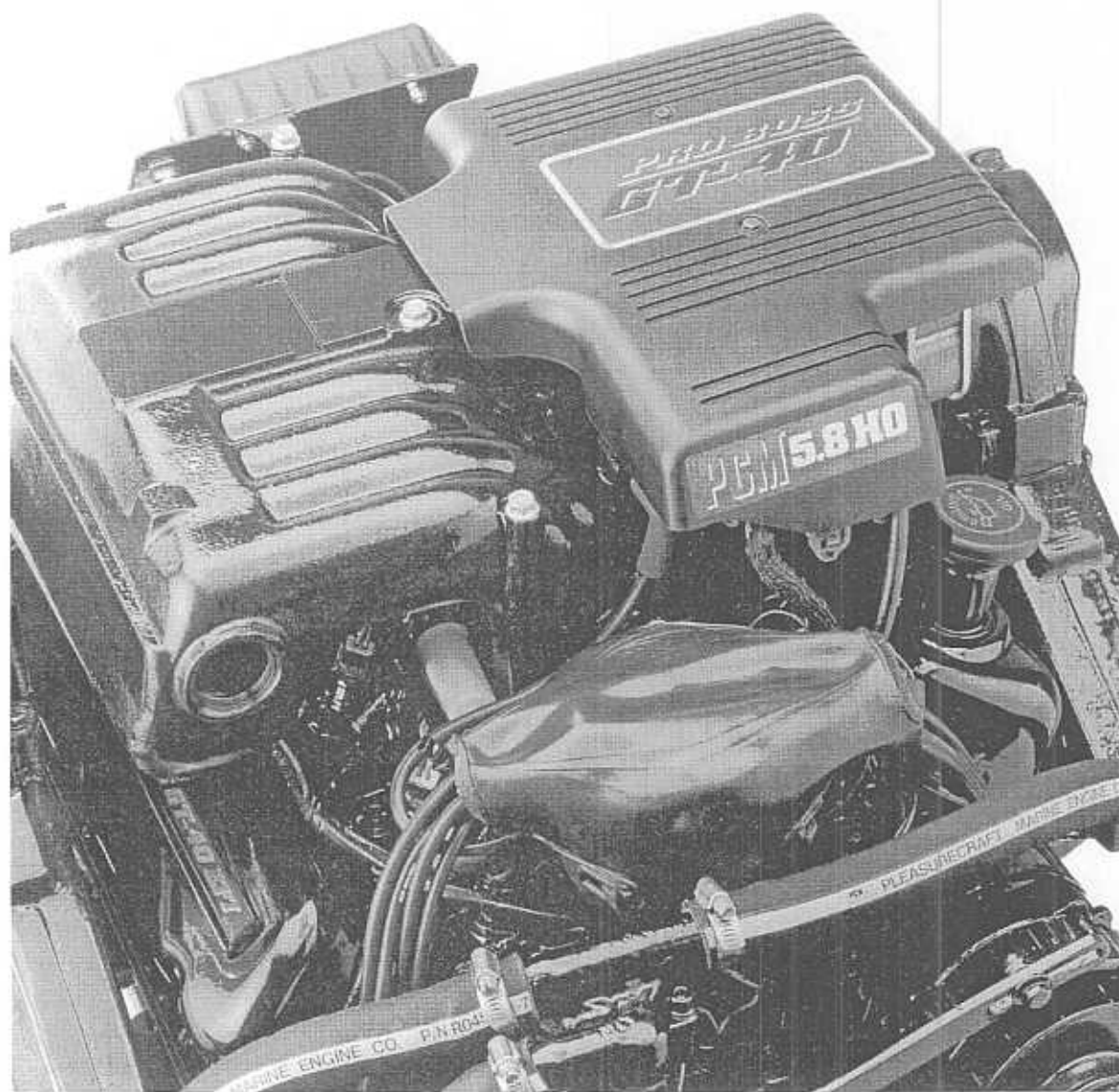

# MANUAL CONTENTS

---

This manual is divided into sections and has a page numbering sequence that uses a section identifying prefix to the page number. This table of contents identifies the sections within this manual.

Each section has it's own table of contents at the beginning of that section.

Introductions .....	1
Warranty Statement .....	2
Correct Craft Addendum .....	3
General Information .....	GN i
Operating Instructions .....	OP i
Maintenance.....	MT i
Specifications .....	SP i
Forms .....	FM i

## INTRODUCTION

---

Thank you for your selection of Pleasurecraft (PCM) Marine Power for your boating needs. We welcome you to Team PCM, which puts you in the company of tens of thousands of boaters who have relied on Pleasurecraft inboards as their power of choice for over 20 years.

When you chose PCM, you selected the utmost in premium power for your boating application. Pleasurecraft is the world's largest manufacturer of gasoline marine inboards and the clear-cut leader in cutting edge technology. Over the years, we've introduced many breakthrough innovations that quickly became industry standards. The pyramidal exhaust system, light-weight transmission, computerized engine control and the fuel control cell are all PCM innovations. No matter which PCM model you purchased, you can be sure it is equipped with the latest in modern technology for added performance and durability.

This Operations Manual is designed to introduce you to the daily operation and maintenance requirements of your PCM engine. Please read it through carefully before running your boat for the first time, and keep it on hand to review from time to time. For more in-depth service and maintenance information, PCM has available a detailed manual designed for those with advanced technical skills. (See page FM2 for ordering information.)

Shortly after your purchase is registered with PCM, you will be mailed your Warranty Card and a Customer Survey. We appreciate your feedback and encourage you to fill out the survey after you've had a chance to run your boat for several weeks. We take this input very seriously, and have implemented many of the ideas our customers have given us via this vehicle.

Again, thanks for choosing PCM. We sincerely wish you happy days on the water.

# General Information

---

## TABLE OF CONTENTS

Engine And Transmission Model And Serial Number Identification Locations .....	GN 1
Glossary Of Terms .....	GN 1
Directional References .....	GN 2
Service Recommendations .....	GN 2
Owner/Operator Responsibilities .....	GN 2
Service For Your PCM Engine .....	GN 2
Literature .....	GN 3
Service Information Request .....	GN 3
PCM Installation And Delivery Inspection .....	GN 3
Fuel Requirements .....	GN 3
Electrical System .....	GN 3
Circuit Breaker(Carburetor Equipped Engines) .....	GN 3
Circuit Breakers (EFI engines) .....	GN 4
Additional Fused Protection .....	GN 4
Battery and Battery Cable Inspection .....	GN 4
Ignition Distributor .....	GN 5
Carburetor Equipped Engines .....	GN 5
EFI Engines .....	GN 5
Cooling System .....	GN 5
Standard .....	GN 5
Optional Fresh Water .....	GN 6
Checking Coolant Level .....	GN 6
Flushing Instructions .....	GN 6

# General Information

**IMPORTANT:** Read this manual carefully and thoroughly; particularly **WARNING, CAUTION, and IMPORTANT** information in bold type, such as this paragraph.



**WARNING:** It is recommended that the battery cables be removed from the battery when the boat is placed in storage, on display, or in transit. This will eliminate the possibility of the engine accidentally starting and causing damage to the engine due to lack of water.

## Engine And Transmission Model And Serial Number Identification Locations

The engine model and serial number of your engine may be found in one of the locations listed below.

1. On a plate bolted onto the center of the intake manifold at the rear.
2. On a plate bolted onto the intake manifold, port and slightly forward of the carburetor.
3. On the port valve cover attached to the inside vertical surface at the front.
4. On the top and at the front of the port valve cover.
5. On a plate bolted onto the intake manifold, port and slightly forward of the carburetor.
6. On the port valve cover just aft of the flame arrestor.

The identification tag contains information formatted as follows.

A	B	C
PLP	PRR12	EFI

The PCM Serial Number and Model Identification tag is laid out as follows:

**Box A** contains information that is used to identify your engine and corresponds with the PCM Model Information listed in the Specification Section of this manual. Use this information to locate the proper maintenance specifications for your service needs. The example given "PLP" may be found on page SP 6.

**Box B** contains transmission information. The specifications list information that corresponds to the numbers (12 in Box B) identifies the transmission as a 1.23:1.

**Box C** identifies special characteristics of your engine. Box C (EFI) indicates the engine has Multi Point Fuel Injection.

Record the information from the Identification plates on the engine and transmission in the spaces below.

	PORT	STARBOARD
Eng. Model		
Eng. Serial #		
Trans. Model		
Trans. Serial #		

**IMPORTANT!** Before performing any operating or maintenance procedure covered in this manual be certain to read the entire manual to insure a full understanding of that procedure.

## Glossary Of Terms

Aft	The back of the Boat.
Clock Wise	Indicates rotation in the same direction as the rotating hands of a clock.
Counter Clockwise	Indicates rotation in the direction opposite to the rotating hands of a clock.
EFI	Means Electronic Fuel Injection
Forward	The front of the Boat.
Fresh Water Cooling System	Indicates a self contained cooling system filled with a coolant such anti-freeze in a tank capped with a pressure cap that is cooled by sea water passing through a heat exchanger.
LH or Left Hand	Indicates Left Hand propeller or engine rotation
MEFI	Means Multi Point Fuel Injection

## General Information

Model Number	The series of letters and numbers on the Serial Plate that describes the engine configuration and content. This series is common to many engines.
PCM	Plesairecraft Marine Engine Co. Inc.
Port	The Left side of the Boat while looking Forward.
RH or Right Hand	Indicates Right Hand propeller or engine rotation.
Sea Water Cooling System	A cooling system which uses only sea water to cool all parts of the engine.
Serial Number	The unique six (6) digit identifying number on the Serial Plate that specifies only one engine.
Starboard	The right side of the boat while looking Forward.
TBI	Means Throttle Body Injection

### Directional References

Directional references are given as they appear when viewing the boat from stern, looking toward bow. The front of the boat is bow; the rear is stern. Starboard side is to the right ; port side is to the left.

### Service Recommendations

This manual includes operation instructions and maintenance schedules that are usually required in normal service. Do not attempt any repairs which are not specifically covered in this manual. Strict compliance to the recommendations for lubrication, maintenance, operation, etc., will assure you of superior performance and dependable service. Improper maintenance or use of unsuitable products will affect your warranty coverage.

### Owner/Operator Responsibilities

It is the operator's responsibility to;

- A) Perform all safety checks before starting the engine.

- B) Ensure that all lubrication and maintenance instructions are complied with, before starting the engine.
- C) Operate the craft in a safe manner.
- D) Return the unit to an Authorized PCM Dealer for warranty service and or necessary maintenance.

Maintenance service and replacement parts, such as but not limited to, tune up parts, filters etc., are the responsibility of the owner/operator and as such, are not considered defects in workmanship or material within the terms of the warranty. The method and frequency of use of your engine determines the need for maintenance service.

### Service For Your PCM Engine

Your PCM engine was manufactured by PCM from the finest materials available and distributed through your dealer who is in the best position to provide you with service. Your dealer is your direct contact to PCM authorized service. Your dealer has the necessary tools and training to properly handle your normal service requirements as well as supply you with the parts, service and service information you may require.

If your PCM dealer is unable to provide you with the parts, service or information you require, he has the knowledge and information necessary to contact PCM on your behalf. The PCM Service Department depends upon specific, and accurate information in order to aid your dealer to respond to your service and part needs. Your dealer has been trained to provide this information.

PCM facilities throughout the world are dedicated to the manufacturing and distributing of the finest marine engines available. Accordingly PCM does not repair engines or engine components in our locations.

In the unlikely event that your dealer, after being requested to do so, cannot satisfy your request for parts or service, please contact the PCM customer service department (see Literature below) for the location of a dealer nearby who will be able to perform the necessary service.

If you are anticipating a trip to an area where you are not aware of the location of a PCM servicing dealer, please contact the PCM customer service department prior to leaving, (see Literature

## General Information

below) for the location of a PCM dealer in the area where you will be traveling.

### Literature

To obtain service and/or parts literature for your PCM Engine(s), contact your dealer, or write:

PCM  
PO Drawer 369  
Little Mountain, SC 29075

### Service Information Request

When contacting the factory about service or part information, please include the following:

1. Your name, address and telephone number.
2. Engine and transmission serial and model numbers.
3. Date purchased.
4. Name of selling or servicing dealer.
5. Boat manufacturer, model and length.
6. Number of hours unit has been operated.
7. Date of previous correspondence.
8. All other pertinent information necessary to allow us to properly respond to your request.

For your convenience, there is a form which can be used when writing PCM on page FM 5.

### PCM Installation And Delivery Inspection

To insure your satisfaction the selling dealer must check the items listed on the PCM Pre Delivery Inspection form prior to delivery of your PCM Engine. Check with him to be sure that these checks have been completed. Items to be checked include, but are not limited to:

- |   |                            |
|---|----------------------------|
| 1) Engine oil                           | 9) Alternator for charge   |
| 2) Timing                               | 10) All lube points        |
| 3) Drive fluid                          | 11) Shaft alignment        |
| 4) Belt tension                         | 12) Control adjustments    |
| 5) Idle speed                           | 13) Battery charge & level |
| 6) Drain Plugs                          | 14) Prop size & rotation   |
| 7) Water lines                          | 15) All fuel & oil lines   |
| 8) Control travel                       | 16) Exhaust hoses & clamp  |
| 17) Check for leaks-water-oil & exhaust |                            |

### Fuel Requirements

Use any good grade automotive regular or

premium gasoline with a minimum average octane rating of 89\* in your PCM engine.

An 87\* average octane gasoline may be used if the gasoline described above is not available; however, the ignition timing *MUST BE* retarded 4°, from the specifications listed in the specifications for your model, to prevent harmful detonation. See specification section.

\* New U.S. Regulation requires posting average of research and motor octane.  $(R + M)/2$ .

Fuel will deteriorate during prolonged storage, causing damage to fuel system gaskets and plastic parts and clogging the passages of the carburetor. Use of a stabilizer can help prevent this.

Fuel used to test PCM engines contains STA BIL<sup>®</sup>, a fuel stabilizer. It is recommended that STA BIL<sup>®</sup> or its equivalent be used according to the manufacturers directions, prior to any lay-up or any period of inactivity longer than thirty (30) days to insure protection of the fuel system components.

PCM reserves the right to refuse warranty on parts which are damaged from using improper gasoline or engines improperly stored.

### Electrical System

A voltmeter is recommended to be used in the instrument panel, accordingly all engines that are produced in our factory are wired for use with a voltmeter. The voltmeter allows:

1. Display of the charge condition of the battery when the ignition switch is turned to the "on" position.
2. Current is to be routed directly from the alternator to the battery. There is virtually no current loss or line drop.
3. Detection of overcharging as an abnormally high voltage reading on the voltmeter so corrections can be made before battery damage occurs.

High voltage can result in battery damage, false instrument readings, and damage electrical components.

Circuit Breaker(Carburetor Equipped Engines)



**CAUTION:** Many boats come equipped with a safety switch, located

## General Information

near the helm, that has a tether attached. This switch must be operational or the engine will not start or continue to run.

The electrical system, of all PCM engines, is protected by at least one 50 AMP circuit breaker under the electrical panel cover at the rear of all carburetor equipped engines. This breaker is designed and assembled to disconnect ALL systems from the battery should an electrical overload occur.

In the event that all electrical systems are dead, turn off all accessories then, push firmly on the red button with the number "50", which protrudes through the electrical cover, until it resets. After the breaker is reset, you should be able to start the engine(s).

If any breaker again disconnects or if resetting does not resolve the problem, have a qualified marine mechanic inspect the engine to determine the cause of the problem.



**WARNING:** *DO NOT* bypass breakers or fuses under any circumstances short of an emergency. Severe damage to the Electrical System and/or personal danger to the operator and other occupants of the boat could occur.

### Circuit Breakers (EFI engines)



**CAUTION:** Many boats come equipped with a safety switch, located near the helm, that has a tether attached. This switch must be operational or the engine will not start or continue to run.

The entire electrical system, of the PCM GT40 engine, is protected by a 50 AMP circuit breaker. The ignition system is protected by its own 12.5 amp breaker, and the fuel pump circuit by its own 15 amp breaker. All protective devices are located on a panel at the rear of the engine.

PCM TBI engines have three fuses and a 50 amp breaker located at the rear of the engine behind the fuel injection ECM. The 50 Amp breaker protects the entire electrical system. The fuses protect the following EFI circuits.

- A. Fuel Pump Fuse - 15 Amp
- B. Injector/ECM Fuse - 10 Amp
- C. ECM / Battery Fuse - 15 Amp

If the engine quits or will not start turn off all accessories. If the battery has enough power to crank the engine using the starter, the breakers should be reset as follows. Push firmly on the red button of each breaker or replace any bad fuse. After the breaker is reset or the fuse replaced, you should be able to start the engine.

If any breaker again disconnects or fuse again blows or if resetting does not resolve the problem, have a qualified marine mechanic inspect the engine to determine the cause of the problem.

### Additional Fused Protection.



**CAUTION:** Many boats come equipped with a safety switch, located near the helm, that has a tether attached. This switch must be operational or the engine will not start or continue to run.

A 40 Amp fuse on all PCM TBI engines and a 50 Amp fuse on the PCM GT40 engine is located within one (1) foot of the large (+) post of the battery. This fuse is designed to protect the engine wiring harness if an electrical overload occurs.

**Note:** The fuse lead to the battery and a quick disconnect in the power feed wire near the ECM may lose contact and cause a no start condition or cause the engine to stop running in the same manner as a blown fuse.

A 20 amp fuse may be located under the boats instrument panel in the ignition switch "I" terminal lead to protect electrical system.

After checking the main breaker, check to see if any of these fuses are blown if key is turned to START and nothing happens.



**WARNING:** *DO NOT* bypass breakers or fuses under any circumstances short of an emergency. Severe damage to the Electrical System and/or personal danger to the operator and other occupants of the boat could occur.

### Battery and Battery Cable Inspection

A fully charged battery is your best insurance that your PCM engine will start each time you go on board. We recommend the use of a 12-volt marine battery with an ampere-hour capacity suitable for engine size. See minimum



# General Information

specifications on page SP 1. Batteries tend to discharge when not in use, the rate of discharge varying with the condition of the battery itself and/or the entire electrical system.

When checking the battery condition, on your volt meter after a reasonable period of disuse, a reading of 10 to 11.5 volts may be found. If voltage reading is 10 volts or below, the battery should be charged by either a charging device or operation of the engine. Upon starting the voltage should immediately raise and within one or two minutes after starting the engine, the voltage reading on the meter should begin to slowly level off at a reading of 13.5 to 14.5 volts, as the engine continues to operate. If the voltage does not rise or rises and stays above 15 volts, after starting the engine, have the charging system checked.

## Ignition Distributor

### Carburetor Equipped Engines



**WARNING:** Distributors on all PCM engines are marine approved and must meet specifications. Use only PCM

Replacement Parts, which are manufactured to the same marine approved standards, as the original equipment parts on your engine when manufactured.



**WARNING:** Removal of the Distributor Cap must be accomplished by first loosening the screws which clamp the Distributor Cap retaining

clips into place. Failure to loosen these screws and prying on the cap could damage the cap and/or destroy the ability of the cap to seal the distributor causing the distributor to become vented and no longer sealed against possible ignition of fuel fumes if present.

Carburetor equipped engines models PLC, PLD, and PLP are equipped with Prestolite Breakerless Distributors. This distributor requires lubrication with a drop of 30W engine oil on the wick under the rotor every 100 hours of engine operation.

### EFI Engines

All PCM EFI engines come equipped with maintenance free distributors. No lubrication or maintenance is necessary for the life of your PCM engine.

## Cooling System

### Standard

The Cooling System of each PCM Marine Engine incorporates a full circulation bypass system, permitting a full flow of water through the engine, even during warmup. Two heavy-duty marine-type pumps are used to accomplish this. A flexible impeller supply pump is used to keep the system full and cool the exhaust system.

A high volume circulating pump maintains full water circulation within the engine to prevent steam pockets and hot spots and assure longer valve and piston ring life. A heavy-duty thermostat is used to control the amount of water which is discharged from the engine after the desired operating temperature is reached. The discharged water is automatically replaced by cool water from the supply pump, maintaining an unusually stable engine temperature through an exceptionally simple system. The hot water is discharged into the exhaust manifold water jackets, further heating the manifold to reduce condensation.

Should overheating occur, stop the engine immediately. Check the water intake and sea strainer, if equipped, and/or transmission cooler for obstruction by weeds, etc. (Plastic sandwich bags and similar containers effectively close off a water intake-DONT LITTER!) Check water pump drive belts for tension and slippage. Inspect water intake hoses for kinks and bends.

On inboard and vee-drive models, check the transmission oil cooler for obstruction of the water tubes.

On all models equipped with engine oil cooler, check the engine oil cooler for obstruction of the water tubes.

A partial inspection of the flexible impeller of the supply pump of some engines can be made by removing the top hose and drive belt from the supply pump and looking into the pump chamber while slowly turning the pump pulley, other engines require removal of the pump for inspection. A badly damaged impeller may be readily detected in this manner.

If a problem is found and corrected, do not attempt to restart until the engine has cooled to normal limits. This is important to prevent engine

## General Information

damage due to thermal shock.



**WARNING:** Removal of hoses from the engine while the boat is on the water may allow water to enter the bilges and could sink the boat. Remove hoses only if you have determined you may do so in complete safety.

### Optional Fresh Water

Engines manufactured with an optional fresh water cooling system, are identified with a "X" in the second position from the left in the model identifier on the engine identification tag. See box A of the information format explanation on page GN 1 of this manual.

The PCM Freshwater Cooling System consists of two (2) sections. The sea water section and the self-contained Fresh Water Section.

The coolant in the freshwater section circulates through the engine block, heads and the intake manifold absorbing the heat created by the engine operation. When the engine is at operating temperature the thermostat allows the coolant to flow around the sides of the tubes in a heat exchanger where heat is transferred to sea water flowing through the center of the heat exchanger tubes. The sea water is then directed into the manifolds and risers where it mixes with the exhaust which is directed overboard.

If overheating occurs the sea water section of this system should be inspected in the same manner as outlined in the "Cooling System (Sea Water)" section of this manual.

### Checking Coolant Level



**WARNING:** Reservoir is equipped with a 14 lb.. (6.35kg) pressure cap. **DO NOT** remove the pressure cap when the engine is hot. To do so could cause personal injury. **ALWAYS ALLOW THE ENGINE TO COOL OFF BEFORE ATTEMPTING TO REMOVE THE PRESSURE CAP.** To remove the cap, turn it a quarter of a turn to the left and allow pressure in cooling system to escape. Then turn cap all-the-way off.

The fresh water section should also be checked for proper coolant level prior to each engine use. Coolant should be maintained at least 1

inch below the pressure cap seat in the expansion tank to insure room for coolant expansion.

If coolant is escaping from the system inspect the system components for leakage, and correct as necessary. Also have pressure cap tested to insure proper operation. A defective cap may allow coolant to escape through the overflow during engine operation and be extremely difficult to detect.

Contact your PCM Dealer at once if this problem cannot be resolved by the above procedures.

### Flushing Instructions

**IMPORTANT:** Drain the sea water section of the cooling system if engine is removed from service in below freezing temperature.

**NOTE:** When engine is operated in salt water, flush it with fresh water periodically and before storage. If engine is flushed while boat is in water, water intake must have a sea water cock installed between water pickup and pump inlet.



**CAUTION:** Do not operate engine without cooling water flowing through water pump or Neoprene water pump impeller will become damaged. ***IF***

***RUNNING THE ENGINE WITH THE BOAT OUT OF THE WATER,*** attach water hose to pump inlet and run engine slowly (650-700 RPM) in neutral to circulate water.

**IMPORTANT:** ***DO NOT*** increase engine speed above 1,000 RPM or water pump damage may occur.

***IF RUNNING THE ENGINE WITH THE BOAT IN THE WATER,*** run the engine at 1,000 to 1,500 RPM. Watch water temperature gauge to prevent overheating.

# OPERATING INSTRUCTIONS

---

## TABLE OF CONTENTS

Starting and Operating .....	OP 1
Check Before Starting .....	OP 1
Check While Running .....	OP 2
Check After Starting .....	OP 2
Operating Limits .....	OP 2
Check After Initial Run .....	OP 2
Starting A Flooded Engine .....	OP 3
Break in .....	OP 3

# OPERATING INSTRUCTIONS

## ALWAYS OBSERVE HIGH SAFETY STANDARDS AND COURTESY AFLOAT!

Consult your local Coast guard Auxiliary or Power Squadron for full details on boating safety.



**WARNING:** Before starting your engine, always ventilate engine compartment by opening hatch or (if equipped) operate bilge blower for a sufficient amount of time to remove any gas fumes from the engine compartment. It is doubly important after repairing, refueling or maintaining to check for fuel spillage or leaks before starting engine. Remove the battery cable from battery before attempting any maintenance or any repairs or when boat is placed in storage or in transit.

## Starting and Operating

A routine pre-starting procedure similar to the one that follows should always be carried out before the first start up of the day.

1. Check oil in engine and transmission.
2. Check for gasoline fumes in bilges or engine compartment.
3. Operate engine room blower for sufficient time to remove any fumes.
4. Operate bilge pump until bilges are dry.
5. Check for adequate fuel in the fuel tank.
6. Check to insure that all necessary safety equipment is on board.

Other items to be inspected may exist, depending upon the nature of the boat. It is advisable to formulate a check list containing all items relative to your boat and follow it faithfully.

**NOTE:** Bilge blowers, bilge pumps, and other accessories should not be connected to the ignition terminal or ignition circuit. Carburetor equipped engines are equipped with an automatic choke which is opened by an electric heating unit. If the ignition is on for one or two minutes prior to starting, the choke will be open and inoperative, and starting may be extremely difficult.

## Check Before Starting

Each time your engine is used the following items must be checked and adjusted if necessary to insure safe enjoyable operation.

1. Engine oil level.
2. Transmission fluid level.
3. Shifting linkage (forward, neutral and reverse) for shift lever in detent and proper direction.
4. Leakage (water, oil and fuel).
5. Coolant level, if fresh water cooled.
6. Operation of throttle and shift controls.
7. Battery condition.
8. Visually inspect for loose mounting fasteners.
9. Insure that the tethered kill switch, located near the helm of your boat, is fully and in electrical contact. See your boats operation manual. Proper methods of checking fluid levels and appropriate cautions to insure safety are found in the MAINTENANCE section of this manual.

Models equipped with inboard transmissions have a factory installed safety switch incorporated, which prevents actuation of the starter unless the shift selector is in neutral. Other models may not.



**WARNING:** Before starting, be sure the shift selector is in neutral.

Before starting a cold engine, equipped with a carburetor, pump the throttle two or three times from closed to open to closed. Open throttle slightly above the idle position and actuate starter.



**CAUTION:** Do not continue to operate starter for more than 30 seconds without pausing to allow starter motor to cool off for 2 minutes. This also will allow battery to recover between starting attempts.

As soon as the engine starts, return the throttle toward closed to establish the engine speed at 1,200 to 1,600 RPM's, and give the engine a short period to warm up and smooth out. When all else is in readiness, reduce speed to idle, shift into gear, and proceed normally. PCM EFI engines do not require throttle pumping prior to starting.

**NOTE:** Pumping the throttle should not be necessary with a warm engine. A warm engine should start readily with the throttle closed by simply actuating the starter.



# OPERATING INSTRUCTIONS

## Check While Running



**WARNING:** In order to prevent personal injury to you or others on board, whenever the engine is running the machinery space must be closed. Never operate the engine with the engine machinery space open or while some one is in the machinery space, either open or closed. Never open the machinery space unless the engine is shut off and the engines rotating parts are stationary and remain in a stationary position. Rotating machinery can cause injury and even death if an accident should occur. Whenever a problem exists that requires the operation of the engine with the machinery space open, extreme care must be exercised. *IT IS RECOMMENDED THAT UNCOVERED ENGINE OPERATION BE ATTEMPTED ONLY BY TRAINED AND QUALIFIED SERVICE PERSONNEL.*

## Check After Starting

1. Oil pressure 35 to 80 PSI (Approx.) at 2000 RPM.
2. Cooling water flow and water temperature 140°-170° R/W and 170°-210° F/W.
3. Idle RPM (600-700) in gear.
4. Maximum forward underway RPM according to specifications for your engine ( see section SP .)
5. Shifting linkage (forward, neutral and reverse) for shift lever in detent and proper direction.
6. Leakage (water, oil and fuel).
7. Exhaust water, oil, fuel system for leaks.
8. General operation of craft.



**CAUTION:** Do not operate at high RPM's in neutral. Do not shift into forward or reverse at speeds above idle RPM's.

During the warmup period, scan the instrument panel for correct operation of all systems. Oil pressure should quickly rise to 35 to 80 lbs. Water temperature should gradually increase to the normal controlled level of 140-170 degrees on direct water cooled models, 170-210 degrees on fresh water heat exchanger equipped cooled models.



**CAUTION:** Do not operate engine without cooling water flowing through water pump or Neoprene water pump impeller will become damaged. *IF RUNNING THE ENGINE WITH THE BOAT OUT*

*OF THE WATER*, attach water hose to pump inlet and run engine slowly (650-700 RPM) in neutral to circulate water. Raising RPMs over 1,000 may cause impeller damage. *IF RUNNING THE ENGINE WITH THE BOAT IN THE WATER*, run the engine at 1,000 to 1,500 RPM. Watch water temperature gauge to prevent overheating.

Alternator charge output should be indicated on the ammeter by the needle indicating toward the (+) side of zero. *IF EQUIPPED WITH A VOLTMETER, THE VOLTAGE SHOULD GRADUALLY RISE TO APPROXIMATELY 13.5 VOLTS OR HIGHER AND REMAIN THERE WHILE THE ENGINE IS OPERATING.*

## Operating Limits

(See Specifications For Your Model)

Maximum RPM, underway at wide open throttle under normal load conditions, can be controlled only by propeller pitch, diameter and design. It is essential that the propeller selected by the installer does not overload or underload the engine.

Extreme overloading, resulting in low RPM's at wide open throttle, will deliver poor performance, poor fuel economy, and eventually result in engine damage.

Underloading, if operated above recommended maximum RPM's, will result in high RPM, poor fuel economy, and engine damage.

Operation in extremely shallow water can cause sand, silt and gravel to be pulled into the cooling system; this can create excessive water pump wear and in extreme cases may deposit in the engine water block water jackets and seriously damage the engine from improper cooling. Heavy weed growth can plug oil coolers and water intakes and cause damage. If operation under these conditions is necessary, a good quality sea water strainer or filter should be installed. The installation of a fresh water cooling system can reduce the danger of engine damage from this cause.

## Check After Initial Run

1. Engine oil level.
2. Transmission fluid level.
3. Leakage (water, oil and fuel).
4. Engine mounting fasteners are tight.
5. Operation of throttle and shift controls.

# OPERATING INSTRUCTIONS

## Starting A Flooded Engine



**WARNING:** If the engine backfires upon attempting to start, the problem may be more serious than flooding. **DO NOT CONTINUE, CONTACT A TECHNICIAN TO CORRECT THE PROBLEM!** To persist in attempting to start the engine under those conditions could cause engine damage or physical harm to you and those around you.

In the event your engine becomes flooded caution should be observed when attempting to start the engine.

Position the throttle in wide open and activate the starter until the engine starts. When the engine starts allow the key to return to the run position and quickly return the throttle to approximately 2,500 RPM's or less, check gauges for normal readings and allow the cylinders to be purged of excess fuel. If gauge readings are abnormal shut the engine off at once and contact your PCM dealer. When the engine runs normally check the engine for fuel, water, and exhaust leaks which must be corrected before proceeding. If no leaks are present, the boat may be safely operated.

## Break in



**CAUTION: DO NOT ATTEMPT TO BREAK IN AN ENGINE BY PROLONGING IDLING OR RUNNING AT THE DOCK.**

After the engine is thoroughly warmed up and the boat is underway, open the throttle wide until full RPM's are reached. DO NOT EXCEED MAXIMUM RPM. (RPM's should cease climbing after 10 to 20 seconds).



**CAUTION: DO NOT OPERATE AT SUSTAINED FULL THROTTLE DURING THE FIRST 5 HOURS OF OPERATION.**

Reduce throttle to 2,800 to 3,000 RPM and cruise at or below this speed for 1/2 hour. Reduce speed to idle, open throttle wide and operate at that speed for approximately 1 minute; reduce to cruise throttle for a few minutes and repeat. (Bringing the engine from idle speed to full throttle will load the engine and assist in seating the piston rings). This cycle can be repeated from time to time during the first 5 hours of operation, but full throttle should not

be sustained for more than 1 to 2 minutes.



**WARNING: FOLLOW THIS PROCEDURE ONLY WHEN CONDITIONS ARE SUCH THAT IT CAN BE DONE IN COMPLETE SAFETY.**

During the early part of the break in period, correct propeller selection can be confirmed. (With a normal load aboard, the engine's RPM's should reach, but not exceed, maximum RPM's as listed under specifications for your model).

During the break-in, all gauges should be watched carefully and speed reduced if abnormal readings become evident.

# MAINTENANCE

## TABLE OF CONTENTS

Replacing Fuel Filter .....	MT 1
Exhaust System .....	MT 1
PCM Transmissions .....	MT 1
Fluid Type .....	MT 1
Change Frequency .....	MT 1
Transmission Fluid Level .....	MT 1
Maintaining Fluid Level On PCM Transmissions .....	MT 1
Method #1 .....	MT 1
Method #2 .....	MT 2
Engine Lubrication .....	MT 2
Selecting Crankcase Oil And Change Intervals .....	MT 2
Changing Engine Oil .....	MT 2
Engine Crankcase Capacity .....	MT 3
Adjusting Water Pump Drive Belt Tension .....	MT 3
Adjusting Alternator Drive Belt Tension .....	MT 4
Fuel Pumps .....	MT 4
Mechanical Fuel Pumps .....	MT 4
Electrical Fuel Pump .....	MT 4
Carburetor Equipped Engines With Electric Fuel Pumps .....	MT 4
Electric Fuel Pumps On EFI Engines .....	MT 4
PCM Fuel Control Cell (FCC) .....	MT 4
Problems Corrected By The PCM FCC .....	MT 5
Principals Of Operation: .....	MT 5
Battery Maintenance .....	MT 5
Spark Plugs .....	MT 6
Spark Plug Removal .....	MT 6
Inspection .....	MT 6
Installation .....	MT 7
Engine Troubleshooting .....	MT 8
Maintenance Chart .....	MT 10



# MAINTENANCE



**WARNING:** The maintenance instructions given in this manual are to be performed with extreme caution.

Improper or careless actions on the part of the person performing maintenance on your boat or engine could result in severe personal injury, property damage and or death. Proceed only when you determine that you may do so in complete safety. Contact your PCM dealer for any maintenance service which you are unable to perform with complete safety.

## Replacing Fuel Filter



**WARNING:** Be careful of spilled fuel; Do not proceed if fuel is spilled. Gas vapor built up is explosive and could cause severe personal injury, property damage or even death. Do not smoke while servicing fuel filters or other fuel system components. Contact your PCM dealer for further assistance.

PCM recommends the use of a fuel filter and/or water separator and fuel filter on all its engines. Fuel filters are standard on all PCM Electronic fuel injection engines as a part of the PCM FCC (fuel control cell). Fuel Filters are not standard on other PCM engines; however, we do offer them as an option to all Boat Builders and Dealers. If your boat is not equipped with a fuel filter, see your PCM Dealer, he can provide you with the proper parts and installation service to protect your engine's fuel system. When replacing the fuel filter element, follow the manufacturer's instructions and the following cautions.

**NOTE:** *DO NOT* re-use old fuel filter components; always replace with new fuel filter and gasket.



**CAUTION:** Do not operate engine without cooling water flowing through water pump or Neoprene water pump impeller will become damaged. *IF RUNNING THE ENGINE WITH THE BOAT OUT OF THE WATER*, attach water hose to pump inlet and run engine slowly (650-700 RPM) in neutral to circulate water. *IF RUNNING THE ENGINE WITH THE BOAT IN THE WATER*, run the engine at 1,000 to 1500 RPM. Watch water temperature gauge to prevent overheating.

The PCM FCC has instructions on the bowl. Follow these instructions carefully when changing the FCC Filter Element.

## Exhaust System

The system should be periodically inspected for leaks and for general condition to prevent leakage of water and exhaust gases into the hull. Flapper valves are suggested to be used on all exhaust systems. Any defects discovered must be corrected as soon as discovered to insure safe operation.



**WARNING:** Removal of hoses from the engine while the boat is on the water may allow water to enter the bilges and could sink the boat. Remove hoses only if you have determined you may do so in complete safety.

## PCM Transmissions

### Fluid Type

All PCM transmissions use DEXRON type Transmission fluid.

### Change Frequency

Change transmission fluid once each year.

### Transmission Fluid Level

The transmission fluid level should be checked frequently and fluid added if necessary. Level must be maintained between the two marks (FULL & LOW) on dipstick.

### Maintaining Fluid Level On PCM Transmissions

Two methods of checking the fluid level are offered as follows. Method #1 is the preferred method but should be attempted by those who are certain that the procedure can be accomplished with absolute safety.

#### Method #1



**WARNING:** In order to prevent personal injury to you or others on board, whenever the engine is running the machinery space must be closed. Never operate the engine with the engine machinery space open or while some one is in the machinery space, either open or closed. Never open the machinery space

# MAINTENANCE

unless the engine is shut off and the engines rotating parts are stationary and remain in a stationary position. Rotating machinery can cause injury and even death if an accident should occur. Whenever a problem exists that requires the operation of the engine with the machinery space open, extreme care must be exercised. *IT IS RECOMMENDED THAT UNCOVERED ENGINE OPERATION BE ATTEMPTED ONLY BY TRAINED AND QUALIFIED SERVICE PERSONNEL.*

1. The boat must be at rest in the water with the engine running at idle speed and the propeller shaft not turning.
2. Pull the dipstick straight up and out of the transmission case to remove dipstick.
3. Wipe the fluid off of the dipstick with a clean cloth.
4. Push dipstick fully into the installed position in transmission fill hole.
5. Remove dipstick and note level indicated. Add fluid, if required, to bring level up to the top mark.

**NOTE!** Add oil in small amounts to prevent overfilling. If the transmission is over filled the excess will have to be removed to prevent leakage or damage to the transmission.

6. Reinstall dipstick.

## Method #2

Method # 2 eliminates the risk of entering the machinery space while the engine is running and should be used by those unwilling to accept the dangers of running machinery.

1. The boat must be at rest in the water.
2. Open the engine cover and pull the dipstick straight up and out of the transmission case to remove dipstick.
3. Wipe the fluid off of the dipstick with a clean cloth.
4. Close the engine compartment and start the engine to fill all the transmission and cooler cavities.
5. Shut the engine off, open the engine compartment and insert the dipstick fully into the transmission case opening. This step should be performed as quickly as safety will permit.
6. Remove dipstick and note level indicated. Add fluid, if required, to bring level up to the top mark.

**NOTE!** Add oil in small amounts to prevent overfilling. If the transmission is over filled the excess will have to be removed to prevent leakage or damage to the transmission.

7. If it was necessary to add oil Repeat steps 1 through 6. Reinstall dipstick.

## Engine Lubrication

### Selecting Crankcase Oil and Change Intervals

The crankcase oil should be selected in order to give the best performance under the climatic and operating conditions prevalent in the area in which the engine is operated. An oil, which will provide adequate lubrication under high operation temperatures, is required during warm or hot weather. An oil, which will permit easy starting at the lowest atmospheric temperature likely to be encountered, should be used during the colder months. When the crankcase is drained and refilled, crankcase oil should be selected on the basis of prevailing temperature for period during which oil is to be used.

AUTOMOTIVE GRADE API "SH" RATED OIL		
		40W40
	30W30	ABOVE 50°F
20W50	32°F to 50°F	
	BELOW 32°F	

We recommend SAE 40W40 of any good grade automotive oil of correct viscosity which has an A.P.I. classification of "SH" for use in all PCM engines. Multiple viscosity oils such as 20W40 and 20W50 which meet the A.P.I. classification "SH" may also be used during cold weather operation.

Engine oil and filter must be changed after the 25-Hour Break-In Period and every 50 hours of operation or every 60 days thereafter, whichever occurs first.

### Changing Engine Oil



**CAUTION:** All engine waste fluids are considered to be hazardous wastes. Be certain these waste fluids are properly and legally disposed of in order to avoid polluting and or possible cite by authorities.

# MAINTENANCE

The engine oil and oil filter of your PCM engine must be changed at the intervals recommended in the maintenance schedules found on page MT 10 of this manual. Oil changing should be carried out as follows.

1. Start engine and allow engine to warm up to normal operating temperature.
2. Drain oil into a suitable container.
3. Position a suitable container under the oil filter and remove the oil filter from the engine. *Be careful not to allow oil to spill into the bilge. Spilled oil must be thoroughly cleaned up and the cleaning materials and oil properly disposed of.*
4. Fill a new oil filter 3/4 full by carefully pouring oil into the threaded hole in the center of the filter. This initial filling of the filter reduces the time that the engine operates without oil flowing through the engine oil passages upon starting.
5. Lubricate the filter gasket with engine oil and install the filter on the block to the point where the gasket lightly contacts the block surface. Tighten the filter an additional 1/4 turn from this point.
6. Fill the engine oil pan with the proper type and grade, as indicated in "Engine Lubrication" above, and proper amount of engine oil for your engine as listed in the specification section of this manual.
7. After checking to determine that you can safely proceed without causing harm to any person, property or the engine, start the engine and carefully watch for oil leaks.
8. If leaks are present, *return the engine to idle speed* and shut off the engine immediately. Repair leaks and repeat step number 7 (seven) above.
9. Dispose of waste oil, old filter and cleaning materials in accordance with the applicable laws.

**IMPORTANT!** Some PCM engines come equipped with oil drain fittings and drain hoses others, a very small number where installation space constraints are severe, require that oil be removed using a pump attached to a tube inserted into the dipstick tube or that the oil pan drain plug be removed. The PCM models PLD and PLP with the dipstick tube located between the port manifold and block has a threaded fitting designed to connect to an oil pumping device for easy removal of oil from the engine.

## Engine Crankcase Capacity



**CAUTION:** The dipstick should be considered as the device which insures the proper oil level. Unless major variations between capacities, listed in specifications, and dipstick readings exist, *always use the dipstick to determine the proper oil level of your engine.*

The engine crankcase capacity is listed in the Specification Section. (Sp section) The installed angle of the engine may change the oil level at the dipstick location, even though your engine oil pan capacity if filled with the amount of oil listed in the specifications, for your engine. Different dipsticks are used on some engines for 0° & 15° installation angles. ***BE CERTAIN THE PROPER AMOUNT OF OIL IS IN THE CRANKCASE AT ALL TIMES. IF ANY QUESTION ARISES, CONTACT YOUR PCM DEALER.***

## Maintaining Engine Oil Level

It must be emphasized that every internal combustion engine should, particularly during the break-in period, use a certain amount of oil to act as a lubricating and cooling agent. The initial rate of consumption will normally, gradually decrease until it becomes stabilized after approximately 100 hours operation.

The engine oil level should be checked frequently and oil added when necessary.

When checking oil levels, the engine should be warm, the boat must be at rest in the water, the dipstick pushed down to the stop. If the engine has been running immediately prior to checking, sufficient time (approximately 1 minute) must be allowed for oil to drain back from the upper engine cavities to the pan or a false reading may be obtained.

The space between the "Full" and "Add" marks represents US one quart. It is not necessary to add oil unless the level is near the "Add" mark. **DO NOT ALLOW THE OIL LEVEL TO FALL BELOW THE ADD MARK!**

## Adjusting Water Pump Drive Belt Tension

1. Check belt tension by depressing upper strand of belt at point midway between the sea water and circulation pump pulleys.
2. Belt should depress 1/4" (6.35mm). If depression is more than 1/4", adjust tension by loosening water pump mounting screws and pivoting pump, as required, to obtain correct

# MAINTENANCE

tension.

3. After correct tension has been set, tighten mounting screws.

## Adjusting Alternator Drive Belt Tension

1. Check belt tension by depressing upper strand of belt at a point midway between the alternator pulley and the circulating water pump pulley.
2. Belt should depress 1/4" (12.7mm). If depression is more than 1/4", adjust tension by loosening alternator mounting screws and pivoting alternator, as required, to obtain correct tension.
3. After correct tension has been set, tighten mounting screws.

If at any time you are unsure as to proper checking or adjusting procedures consult your dealer for guidance.

## Fuel Pumps

Three different types of fuel pumps are currently used on PCM engines. The three types are:

- 1) Mechanical
- 2) Low Pressure Electrical (Feed)
- 3) High Pressure Electrical (Injection)

Mechanical and low pressure electrical pumps operate at 5 to 7 PSI, while high pressure pumps operate between 30 to 40 PSI.

### Mechanical Fuel Pumps

Mechanical fuel pumps will be found on all PLC, PLD with carburetors. All mechanical fuel pumps used on PCM engines are special marine fuel pump sealed against leakage in the attaching flange area to prevent the possibility of fuel entry into the engine crankcase. In the event that the fuel pump diaphragm ruptures fuel will appear in the sight tube attached to the fuel pump and the carburetor. When fuel appears in the sight tube it will be necessary to replace the fuel pump immediately, to correct the problem. **REBUILDING OF THE PUMP IS NOT RECOMMENDED!!**

### Electrical Fuel Pump

The electric feed pump being used on all PCM engines, other than the PLC and PLD models, is a high volume, internally regulated low pressure, constant flow, rotary vane, fully sealed, non repairable, marine approved fuel pump. The power source is 12 volt negative (-) ground and the pump operates at less than 5

amps.

### Carburetor Equipped Engines With Electric Fuel Pumps

With the ignition on power is supplied through the ignition switch to an oil pressure switch mounted at the left side of the electrical bracket. This switch activates only when the engine is running to prevent the pump from operating if the ignition switch is inadvertently left in the on position.



**WARNING: Do not bypass this switch!**

During cranking of the engine a bypass circuit allows the fuel pump to function thus allowing priming after lay-up or in the event that the fuel tank is ran dry.

The pump circuit is protected by a 5 amp fuse (BUSS # MDL 5) in the water proof fuse holder located between the left rocker cover and the carburetor. Due to the fact that the pump is isolated in mounting the electrical circuit is completed through a ground wire attached next to the power lead on the bottom of the pump.

**IMPORTANT! The pump terminals must be connected properly to prevent pump damage and or proper operation. The power (+) lead must be contacted to the terminal closest to the "OUT" fitting of the pump. The ground (-) lead must be connected to the terminal closest to the "IN" fitting of the pump.**

### Electric Fuel Pumps On EFI Engines

When the ignition switch is turned "ON", the Electronic Control Module (ECM) turns the fuel pump relay "ON" causing the fuel feed pump to fill the FCC bowl. At the same time the high pressure fuel pump in the FCC is turned on to pressurize the throttle body or fuel rail. After two seconds if the engine is not started the fuel pumps are shut off by the Electronic Control Module (ECM).

When the ignition switch is turned to the crank or start position, the ECM closes the fuel pump relay causing the fuel pump to run.

If the ECM does not receive ignition reference pulses (engine cranking or running), it shuts "OFF" the fuel pump relay, causing the fuel pump to stop.

An inoperative fuel pump relay will result in an "Engine Cranks But Won't Run" condition.

# MAINTENANCE

## PCM Fuel Control Cell (FCC)

The PCM Fuel Control Cell (FCC) is designed to properly deliver fuel to your electronically fuel injected (EFI) PCM marine engine under the various operating conditions which a marine engine encounters. The FCC incorporates an electric fuel pump, a fuel filter, a water separator and a reservoir system.

The FCC is the first unit to combine a submersible high pressure electric fuel pump, a fuel filter and water separator element into one system. Further more the system has been coupled with the proper sized feed pump and has had extensive calibration done to the manifold to address the different problems encountered by a marine inboard electronically fuel injected engine. The FCC addresses and corrects all fuel delivery system problems we are currently aware of and does so with a minimum of electro-mechanical components.

To insure reliable maintenance free operation, the FCC does not use floats, electric switches or other devices to regulate the fuel flow or level of the fuel. Any moving components, electronic switches or contacts submerged in gasoline will eventually corrode, varnish or wear out and will require future maintenance. It was the goal of the FCC design to provide maximum reliability while eliminating unnecessary components.

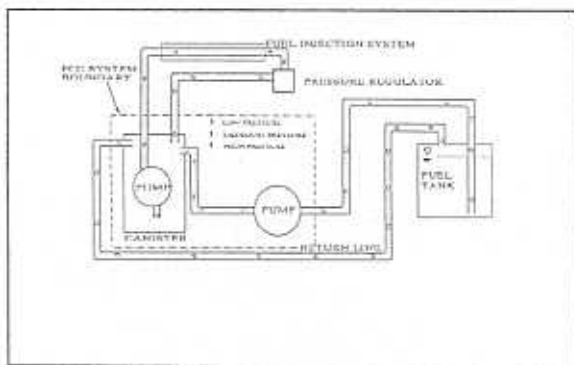

### Problems Corrected By The PCM FCC

An inboard marine engine with electronic fuel injection can encounter several problems with fuel delivery which can cause poor performance or even result in disabling the engine. A few of the problems which can occur due to an improperly designed fuel delivery system are;

- 1.) Vapor lock
- 2.) Particulate Contamination
- 3.) Water Ingestion
- 4.) Air Ingestion

The FCC addresses these problems by eliminating vapor lock and air ingestion caused by fuel tank slosh and provides the necessary EFI filtration and water separation.

### Principals Of Operation:

The FCC incorporates two (2) fuel pumps to provide an uninterrupted flow of fuel to your PCM marine engine.

Fuel is fed into the FCC by a low pressure, high volume electric fuel pump. This pump flows fuel at a volume which exceeds the fuel flow rate required of the high pressure pump by engine demands.

The high pressure pump, mounted inside the FCC bowl, provides the necessary fuel pressure and volume to maintain proper engine performance and always has an ample supply of fuel to meet the idle, cruise and acceleration fuel requirements of the engine.

The fuel pressure regulator, located on the engine, controls fuel pressure and maintains a constant pressure across the fuel delivery system. Fuel not used by the engine, excess fuel, returns to the FCC canister.

The fuel delivered to the engine by the FCC is filtered by a filter and water separator element which surrounds the high pressure pump inside the FCC bowl.

As indicated above fuel enters the FCC bowl from two (2) components, the low pressure pump (initial input) and the fuel pressure regulator (unused recirculating). Fuel exits the FCC bowl at two (2) points, the high pressure output to the fuel injection system and all excess fuel in the FCC canister is routed back to the tank via the return line. See the flow diagram above, the assembly drawing which follows, or the FCC. The FCC is controlled in the manner described in "Electric Fuel Pumps on EFI Engines"

## Battery Maintenance



**WARNING:** Hydrogen and oxygen gases are produced during normal battery operation or charging. Sparks or flame near the vent openings can cause this mixture to ignite and explode. Sulfuric acid in the battery can cause serious burns if spilled on the skin or in the eyes. Proper eye protection and protective clothing should be worn when performing battery maintenance. Flush or wash away acid spills immediately with clear water. Contact a physician for medical treatment if acid comes in contact with your body.

# MAINTENANCE

Check battery with a hydrometer. If reading is below 1.230 (specific gravity), recharge or replace the present battery.

Inspect battery and cables for signs of corrosion on battery, cables and surrounding area, loose or broken battery box, cracked or bulged cases, dirt and acid, electrolyte leakage and low electrolyte level. Fill cells to the proper level with distilled water.

The top of the battery should be clean and the battery box and/or hold-down bolts properly tightened. Particular care should be taken so that the top of the battery is kept clean of acid film and dirt to prevent a short between the battery terminals.



**CAUTION:** Be certain to use the proper tools to remove the cables from the battery. Always disconnect the negative (-) cable first.

*After removing battery from the boat,* wash first with a diluted ammonia or soda solution to neutralize any acid present and then flush off with clean water. Care must be taken to keep vent plugs tight so that the neutralizing solution does not enter the cells.

To ensure good contact, the battery cables should be tight on the battery posts. If the battery posts or cable terminals are corroded, clean separately with a soda solution and wire brush. After cleaning and before installing clamps, apply a thin coating of petroleum grease to the posts and cable clamps to help retard corrosion. Reinstall as follows:



**CAUTION:** Engine electrical system is negative ground. Failure to connect battery leads, as outlined, will damage the system.

1. The battery should be contained in a leak proof battery box, positioned as close to the engine as possible and should be securely mounted in boat.
2. If removed, connect the negative (-) battery cable to ground on engine.
3. If removed, connect the positive (+) battery cable to the solenoid.
4. First connect the positive (+) battery cable to the positive (+) post on the battery and then the negative (-) battery cable to the negative (-) post on the battery.

Batteries should always be removed from the boat for flushing and/or recharging with battery chargers.

If the battery has remained undercharged, the local servicing dealer should check for loose alternator belt,

defective alternator components, high resistance in the charging circuit or a low voltage output.

## Spark Plugs

Stray sparks can ignite an explosive atmosphere if present and stray electrical energy in the form of radiate energy (radio waves) can cause sensitive electronic circuits to malfunction. This can cause engine operation to deteriorate and increase the possibility of engine damage. The following cautions and procedures are designed to minimize the possibility of either stray spark or radiated energy from occurring.

### Spark Plug Removal

#### Disconnect and Remove

1. Negative battery cable.
2. Twist boots one-half turn then remove spark plug wires and boots.

**IMPORTANT!** When removing the boot, *do not* use pliers or other tools that may tear the boot. *Do not* force anything between the wire and the boot, or through the silicone jacket of the wiring. *Do not* pull on the wires to remove the boot.

**DO!** Pull on the boot, or use a tool designed for this purpose. **DO!** label the plug wires if the identification numbers have worn off.

3. Spark plugs.

### Inspection

1. Inspect each plug individually every 100 hours for badly worn electrodes, glazed, broken or blistered porcelain and replace where necessary. **NOTE:** Spark plugs should be replaced after 200 hours of operation. Always use the recommended Spark Plugs. See specifications for your engine for proper numbers.
2. Inspect each spark plug for make, number, and heat range. All plugs must be the same brand and number.

**IMPORTANT!** *Improper heat range may cause major engine damage.*



**CAUTION:** Never bend the center electrode to adjust gap. Always adjust by bending ground or side electrode.

3. Adjust spark plug gaps with a round feeler gauge. (See "Specifications.") Replace defective plugs.

# MAINTENANCE

---

## Installation

1. Always keep spark plug seats in cylinder head clean. If spark plugs will not thread into the head to the point where they contact the seat by hand, clean the threads in the cylinder head before installing the plugs.

**NOTE:** *Improper installation may cause unsatisfactory spark plug performance and engine damage.*

2. Install spark plugs to engine and torque to 11 ft. lbs. (15 N.m).
3. Replace or repair any loose or damaged spark plug wires. Install all wires to proper spark plug. Proper positioning of spark plug wires in supports is important to prevent cross-firing.

**IMPORTANT!** Special care should be used when installing spark plug boots to make sure the metal terminal within the boot is fully seated on the spark plug terminal and the boot has not moved on the wire. If boot to wire movement has occurred, the boot will give a false visual impression of being fully seated. A good check to make sure the boots have been properly installed is to push sideways on them. If they have been correctly installed, a stiff boot with only slight looseness will be noted. If the terminal has not been properly seated on the spark plug, only the resistance of the rubber boot will be felt when pushing sideways.

Replacement Wire routings must be kept intact during service and followed exactly when wires have been disconnected, or when replacement of the wires is necessary. Failure to route the wires properly can lead to radio noise and cross-firing of the plugs, or shorting of the leads to ground.

# MAINTENANCE

## Engine Troubleshooting

**IMPORTANT:** The following chart is a guide to aid you to find and correct minor engine malfunctions. If the problem has not been corrected after following the guide, DO NOT attempt further repairs. See your authorized PCM Dealer.



**WARNING:** Before attempting any checks or repairs, the battery cable **MUST BE REMOVED** from the battery to prevent possible personal injury or damage to equipment.

Trouble	Cause	What You Can Do About It
1. Starter won't turn engine	A. Control lever not in neutral. B. Loose or corroded battery connections. C. Weak battery. D. Tethered switch key not inserted or not making contact.	Make sure control lever is exactly in neutral Tighten cables on battery. If corroded, clean as described under "Battery Maintenance." Check level of electrolyte and refer to "Battery Maintenance." Remove then insert tethered switch key into switch.
2. Engine won't or is hard to start.	A. Empty fuel tank. B. Tank vent clogged. C. Shut-off valve closed. D. Clogged fuel filter. E. Choke not operating properly. F. Engine flooded. G. Fouled spark plugs or gap wrong. H. Cracked or dirty distributor Clean or replace cap or rotor. I. Poor connections or damaged connections	Check fuel supply. Make sure vent is free of obstruction. Check valve to make sure it is open. Inspect fuel filter. Replace if necessary, as outlined under "Replacing Fuel Filter." Inspect carburetor choke linkage for any binding or obstructions. Do not attempt to start engine for at least 5 minutes. Inspect spark plugs. Clean and gap or replace. Inspect contacts and or surfaces.
3. Poor idling or binding or engine misses while idling	J. Tethered switch key not inserted or not making contact. A. Choke not operating properly. B. Corroded wire ends or distributor cap towers C. Fouled spark plugs or gap wrong. D. Weak battery. E. Cracked or dirty distributor D. Tank vent clogged.	Check wires for wear or breaks and tighten all loose ignition wiring. Remove then insert tethered switch key into switch. Inspect carburetor choke linkage obstructions. Check wires and towers for corrosion. Clean or replace. Inspect spark plugs. Clean or replace. Check level of electrolyte and refer to "Battery Maintenance." Inspect contacts and surfaces. Clean or replace. Make sure vent is free of obstruction.



# MAINTENANCE

<p>4. Engine misses on acceleration or at high speed (loss of power)</p>	<p>E. Clogged fuel filter.</p> <p>F. Fouled spark plugs or gap wrong.</p> <p>A. Fouled spark plugs or gap wrong. B. Cracked or dirty distributor</p> <p>C. Poor connections or damaged ignition wiring</p>	<p>Inspect fuel filter. Replace if necessary, as outlined under "Replacing Fuel Filter"</p> <p>Inspect spark plugs. Clean or replace.</p> <p>Inspect plugs, clean or replace.</p> <p>Inspect contacts and surfaces. Clean or replace cap or rotor.</p> <p>Check wires for wear or breaks and tighten all loose connections.</p>
<p>5. Oil pressure drop</p>	<p>A. Low oil level.</p> <p>B. Clogged oil filter.</p>	<p>Refer to "Maintaining Engine Oil Level."</p> <p>Refer to "Draining Engine Oil and Replacing Oil Filter."</p>
<p>6. Engine backfires</p>	<p>A. Spark plug leads installed wrong.</p>	<p>Make sure correct lead is installed on proper plug and proper tower in distributor cap.</p>
<p>7. Alternator will not charge</p>	<p>A. Drive belt loose, or has low output. B. Connections loose or dirty.</p> <p>C. Unacceptable battery condition.</p>	<p>Refer to "Alternator Charging System."</p> <p>Inspect connections for corrosion and tighten all loose connections.</p>
<p>8. Performance loss and poor acceleration</p>	<p>A. Throttle not fully open. B. Excessive water in bilge. C. Boat overload. D. Tank vent clogged.</p> <p>E. Clogged fuel filter.</p> <p>F. Fouled spark plugs.</p>	<p>Check level of electrolyte and refer to "Battery Maintenance."</p> <p>Inspect cable and linkage for binding or obstruction</p> <p>Drain or pump water out of bilge. Reduce load.</p> <p>Make sure vent is free of obstruction.</p> <p>Inspect fuel filter. Replace if necessary, as outlined under "Replacing Fuel Filter."</p> <p>Clean or replace.</p>

# MAINTENANCE

## Maintenance Chart

This chart indicates the intervals at which maintenance should be performed by a qualified person. maintenance operations require caution to prevent personal injury and/or property damage. Proceed only after you have determined that you may do so in *complete safety* or contact a qualified technician to perform these operations for you.

**Service or Checking at the Most Frequent Interval Listed is Recommended**

	Before Each Use	Weekly	At 1st 25 Hours of Operation	Every 50 Hours of Operation	Every 100 Hours of Operation	Once Each Year
Check Engine Oil	X					
Change Engine Oil		1	1	1	1	1
Replace Oil Filter		X	X	X	X	X
Check Transmission Fluid Level	X					
Check Sea Water Strainer	X	2	2	2	2	2
Check Water Pump & Alternator Belts for Tension	X					
Check Fuel System Lines and Connectors-Leak	X	X	X	X	X	X
Check Cooling System Hoses& Connections-Leaks	X					
Check for Loose, Damaged or Missing Parts	X					

**The following operations must be performed by a QUALIFIED TECHNICIAN**

*Check Engine to Propeller Shaft Alignment			X			X
*Change Transmission Fluid				X		
*Clean Flame Arrestor			X		X	X
*Clean Crankcase Ventilating System			X		X	X
*Change Fuel Filter					X	X
*Check Condition of Spark Plugs			X		X	X
*Check Battery Electrolyte Level			X	X	X	
*Check All Electrical Connections			X			X
*Lubricate Throttle and Shift Linkage Pivot Points			3			3

The inspection and maintenance schedule, above, is based on average operating conditions in utility service. Under severe operating, intervals should be shortened.

- 1) Refer to Viscosity Chart on Page MT 2. Change oil *before* annual layup.
- 2) If engine overheats, visually check. If clogged, clean out.
- 3) 30w Engine oil.



**CAUTION:**

All engine waste fluids *are considered to be hazardous wastes*. Be certain these waste fluids are properly and legally disposed of in order to avoid polluting and or possible cite by authorities.

# SPECIFICATIONS

## TABLE OF CONTENTS

Battery Specifications ( <u>Minimum</u> ) .....	SP 1
Closed Cooling System .....	SP 1
PCM Transmissions .....	SP 1
Specifications Common To All Pleasurecraft Engines .....	SP 1
PCM Engine Model PLA MFI (APEX) .....	SP 2
PCM Engine Model PLC .....	SP 2
PCM Engine Model PLD .....	SP 3
PCM Engine Model PLH .....	SP 3
PCM Engine Model PLK .....	SP 4
PCM Engine Model PLK TBI .....	SP 4
PCM Engine Model PLL .....	SP 5
PCM Engine Model PLL TBI .....	SP 5
PCM Engine Model PLN .....	SP 6
PCM Engine Model PLP .....	SP 6
PCM Engine Model PLP EFI (GT40) .....	SP 7
NOTES .....	SP 8

# SPECIFICATIONS

## Battery Specifications (Minimum)

12 Volt Marine Type with Tapered Post Connectors

Engine Size	Cold Crank @ 0° F (-18° C)	Amps for Load Test	25 Amp Rate Reserve Capacity (Minutes)
305 V-8 & 302 V-8	350 Amps	170	80
350 V-8 & 351 V-8	350 Amps	170	80
454 V-8 & 460 V-8	465 Amps	230	125

**IMPORTANT:** The engine electrical system is negative ground. Failure to connect battery leads accordingly will damage the electrical system.

**CAUTION:** All engine waste fluids are considered to be hazardous wastes. Be certain these waste fluids are properly and legally disposed of in order to avoid polluting and/or possible cite by authorities.

## Closed Cooling System

Engine	Capacity	Pressure Cap	Anti freeze/Water
5, 5.8, & 5.7 liter engines	16 Qt.	14 PSI	50%/50%
7.4 liter engines	24 Qt.	14 PSI	50%/50%

Capacity is approximate. Add 50% anti freeze then complete the fill with clean water.

## PCM Transmissions

Approximate Oil Capacity (Transmission only)

Manufacturer	Model	Installed Angle	Capacity
PCM	40I 1:1	10 to 16 degrees	2 US Qts.
PCM	40A 1.23:1	0 to 5 Degrees	2 US Qts.

**NOTE:** Oil capacity may not include capacity needed for transmission cooler and oil lines, which may require an amount greater than in the table above.

## Specifications Common To All Pleasurecraft Engines

Recommended Fuel (R+M)/2	Unleaded 89 Octane Minimum	See Note #3 B
Recommended Engine Oil	Premium Grade "SH" Rated	
Recommended Transmission Oil	DEXRON	
Marine Approved Electrical System	12 Volt Neg. (-) Ground	See Note #4
Marine Approved Fuel Feed Pumps	Mechanical and Electric	See Note #1
Operating Pressure; All Feed Pumps	5.5 ± .5 PSI	See Note #1
Marine Approved Circuit Breakers	60, 15, 12.5 Amp	See Note #1
Marine Approved Alternator	50 Amp	See Note #1
Marine Approved Regulator	Integral Solid State	See Note #1

ALL NOTES APPEAR ON PAGE # SP 8

# SPECIFICATIONS

## PCM Engine Model PLA MFI (APEX)

Displacement CID/liter	350/5.7	
Bore (inches)	4.000"	
Stroke (inches)	3.480	
Compression Ratio	9.4:1	
Horsepower @ 5,000 RPM	320	
Battery Recommended Min. CCA	350	See Note #4
Fuel Injection (Multi Point)	8 (30#)	See Note #1
Spark Plug Number 14mm	MR43LTS (AC)	
MAXIMUM (Intermittent) RPM's	5,000	See Note #9
Continuous Cruise RPM's (Max)	4,000	See Note #2
Idle Speed (in forward gear)	650 - 700	ECM Controlled
Distributor (Marine Approved)	Delco Electronic	ECM Controlled See Note #1
Ignition Timing @ 1,000 RPM	10° BTDC	See Note #3 B & Note #11
Spark Plug Gap	.045"	
Firing Order	1-8-4-3-6-5-7-2	See Note #6
Fuel Pump (Low Pressure Feed)	5 to 6 PSI	See Note #1
Fuel Pump (High Pressure Injector)	39 (± 3) PSI	See Note #10
Oil Pan Capacity	6 qt. @ 0° & 5 qt @ 15°	See Note #5 & 8

ALL NOTES APPEAR ON PAGE # SP 8

## PCM Engine Model PLC

Displacement CID/liter	302/5.0	
Bore (inches)	4.00"	
Stroke (inches)	3.00"	
Compression Ratio	8.4:1	
Horsepower @ 4,400 RPM	215	
Battery Recommended Min. CCA	300	See Note #4
Carburetor (Marine Approved)	Holley 4V	See Note #1
Spark Plug Number 14mm	ASF 32 M (Motorcraft)	See Note #7
MAXIMUM (Intermittent) RPM's	4400	
Continuous Cruise RPM's (Max)	3600	See Note #2
Idle Speed (in forward gear)	650-700 RPM	
Distributor (Marine Approved)	Prestolite Breakerless	See Note #1
Ignition Timing @ Idle	10° BTDC	See Note #3 A&B
Spark Plug Gap	.045	
Firing Order	1-3-7-2-6-5-4-8	See Note #6
Fuel Pump Operating Pressure	5-6 # PSI	See Note #1
Oil Pan Capacity	4 Qts.	See Note #5

ALL NOTES APPEAR ON PAGE # SP 8

# SPECIFICATIONS

## PCM Engine Model PLD

Displacement CID/liter	351/5.8	
Bore (inches)	4.00"	
Stroke (inches)	3.50"	
Compression Ratio	8.3:1	
Horsepower @ 4,400 RPM	260	
Battery Recommended Min. CCA	350	See Note #4
Carburetor (Marine Approved)	Holley 4V	See Note #1
Spark Plug Number 14mm	ASF32M (Motorcraft)	See Note #7
MAXIMUM (Intermittent) RPM's	4400	
Continuous Cruise RPM's (Max)	3600	See Note #2
Idle Speed (in forward gear)	650-700	
Distributor (Marine Approved)	Prestolite Breakerless	See Note #1
Ignition Timing @ Idle	10° BTDC	See Note #3 A&B
Spark Plug Gap	.045	
Firing Order	1-3-7-2-6-5-4-8	See Note #6
Fuel Pump Operating Pressure	5-6 # PSI	See Note #1
Oil Pan Capacity	4 Qts.	See Note #5

ALL NOTES APPEAR ON PAGE # SP 8

## PCM Engine Model PLH

Displacement CID/liter	350/5.7	
Bore (inches)	4.000"	
Stroke (inches)	3.480"	
Compression Ratio	9.1:1	
Horsepower @ 4,400 RPM	260	
Battery Recommended Min. CCA	350	See Note #4
Carburetor (Marine Approved)	Holley 4V	See Note #1
Spark Plug Number 14mm	MR43T (AC)	
MAXIMUM (Intermittent) RPM's	4,400	
Continuous Cruise RPM's (Max)	3,600	See Note #2
Distributor (Marine Approved)	Delco Electronic	See Note #1
Idle Speed (in forward gear)	650 to 700	
Ignition Timing @ Idle RPM	10° BTDC	See Note #3 B & Note #11
Spark Plug Gap	.035"	
Firing Order	1-8-4-3-6-5-7-2	See Note #6
Electric Fuel Pump	5-6 PSI	See Note #1
Oil Pan Capacity	6 qt. @ 0° & 5 qt @ 15°	See Note #5 & 8

ALL NOTES APPEAR ON PAGE # SP 8

# SPECIFICATIONS

## PCM Engine Model PLK

Displacement CID/liter	454/7.4	
Bore (inches)	4.250"	
Stroke (inches)	4.000"	
Compression Ratio	8.12:1	
Horsepower @ 4,800 RPM	350	
Battery Recommended Min. CCA	450	See Note #4
Carburetor (Marine Approved)	Holley 4V	See Note #1
Spark Plug Number 14mm	MR43T (AC)	
MAXIMUM (Intermittent) RPM's	4,400	
Continuous Cruise RPM's (Max)	3,600	See Note #2
Idle Speed (in forward gear)	650 - 700	
Distributor (Marine Approved)	Delco Electronic	See Note #1
Ignition Timing @ Idle RPM	10° BTDC	See Note #3 B & Note #11
Spark Plug Gap	.045"	
Firing Order	1-8-4-3-6-5-7-2	See Note #6
Electric Fuel Pump	5 to 6 PSI	See Note #1
Oil Pan Capacity	6 qt. @ 0° & 5 qt @ 15°	See Note #5 & 8

ALL NOTES APPEAR ON PAGE # SP 8

## PCM Engine Model PLK TBI

Displacement CID/liter	454/7.4	
Bore (inches)	4.250"	
Stroke (inches)	4.000"	
Compression Ratio	8.12:1	
Horsepower @ 4,800 RPM	365	
Battery Recommended Min. CCA	450	See Note #4
Fuel injection	Rochester TBI	See Note #1
Spark Plug Number 14mm	MR43T (AC)	
MAXIMUM (Intermittent) RPM's	4,400	See Note #9
Continuous Cruise RPM's (Max)	3,600	See Note #2
Idle Speed (in forward gear)	650 - 700	ECM Controlled
Distributor (Marine Approved)	Delco Electronic	ECM Controlled See Note #1
Ignition Timing @ Idle RPM	10° BTDC	See Note #3 B & Note #11
Spark Plug Gap	.045"	
Firing Order	1-8-4-3-6-5-7-2	See Note #6
Fuel Pump (Low Pressure Feed)	5 to 6 PSI	See Note #1
Fuel Pump (High Pressure Injector)	30 PSI	See Note #1
Oil Pan Capacity	6 qt. @ 0° & 5 qt @ 15°	See Note #5 & 8

ALL NOTES APPEAR ON PAGE # SP 8

# SPECIFICATIONS

## PCM Engine Model PLL

Displacement CID/liter	350/5.7	
Bore (inches)	4.000"	
Stroke (inches)	3.480"	
Compression Ratio	9.1:1	
Horsepower @ 4,400 RPM	270	
Battery Recommended Min. CCA	350	See Note #4
Carburetor (Marine Approved)	Holley 4V	See Note #1
Spark Plug Number 14mm	MR43T (AC)	
MAXIMUM (Intermittent) RPM's	4,400	
Continuous Cruise RPM's (Max)	3,600	See Note #2
Distributor (Marine Approved)	Delco Electronic	See Note #1
Idle Speed (in forward gear)	650 to 700	
Ignition Timing @ Idle RPM	10° BTDC	See Note #3 B & Note #11
Spark Plug Gap	.045"	
Firing Order	1-8-4-3-6-5-7-2	See Note #6
Electric Fuel Pump	5-6 PSI	See Note #1
Oil Pan Capacity	6 qt. @ 0° & 5 qt @ 15°	See Note #5 & 8

ALL NOTES APPEAR ON PAGE # SP 8

## PCM Engine Model PLL TBI

Displacement CID/liter	350/5.7	
Bore (inches)	4.000"	
Stroke (inches)	3.480	
Compression Ratio	9.3:1	
Horsepower @ 4,400 RPM	275	
Battery Recommended Min. CCA	350	See Note #4
Fuel Injection (TBI)	Rochester	See Note #1
Spark Plug Number 14mm	MR43T (AC)	
MAXIMUM (Intermittent) RPM's	4,400	See Note #9
Continuous Cruise RPM's (Max)	3,600	See Note #2
Idle Speed (in forward gear)	650 - 700	ECM Controlled
Distributor (Marine Approved)	Delco Electronic	ECM Controlled See Note #1
Ignition Timing @ 1,000 RPM	10° BTDC	See Note #3 B & Note #11
Spark Plug Gap	.045"	
Firing Order	1-8-4-3-6-5-7-2	See Note #6
Fuel Pump (Low Pressure Feed)	5 to 6 PSI	See Note #1
Fuel Pump (High Pressure Injector)	30 PSI	See Note #1
Oil Pan Capacity	6 qt. @ 0° & 5 qt @ 15°	See Note #5 & 8

ALL NOTES APPEAR ON PAGE # SP 8



# SPECIFICATIONS

## PCM Engine Model PLN

Displacement CID/liter	454/7.4	
Bore (inches)	4.250"	
Stroke (inches)	4.000"	
Compression Ratio	8.63:1	
Horsepower @ 4,800 RPM	400	
Battery Recommended Min. CCA	450	See Note #4
Carburetor (Marine Approved)	Holley 4V D/P	See Note #1
Spark Plug Number 14mm	MR43T (AC)	
MAXIMUM (Intermittent) RPM's	5,200	
Continuous Cruise RPM's (Max)	4,100	See Note #2
Idle Speed (in forward gear)	650 to 700	
Distributor (Marine Approved)	Delco Electronic	See Note #1
Ignition Timing @ Idle RPM	7° BTDC	See Note #3 B & Note #11
Spark Plug Gap	.045"	
Firing Order	1-8-4-3-6-5-7-2	See Note #6
Electric Fuel Pump	5-6 PSI	See Note #1
Oil Pan Capacity	6 qt. @ 0° & 5 qt @ 15°	See Note #5 & 8

ALL NOTES APPEAR ON PAGE # SP 8

## PCM Engine Model PLP

Displacement CID/liter	351/5.8	
Bore (inches)	4.00"	
Stroke (inches)	3.50"	
Compression Ratio	8.3:1	
Horsepower @ 4,800 RPM	285	
Battery Recommended Min. CCA	350	See Note #4
Carburetor (Marine Approved)	Holley 4V	See Note #1
Spark Plug Number 14mm	AWSF22 (Motorcraft)	See Note #7
MAXIMUM (Intermittent) RPM's	4800	
Continuous Cruise RPM's (Max)	4000 to 4200	See Note #2
Idle Speed (in forward gear)	650-700	
Distributor (Marine Approved)	Prestolite Breakerless	See Note #1
Ignition Timing @ Idle RPM	10° BTDC	See Note #3 A & B
Spark Plug Gap	.045	
Firing Order	1-3-7-2-6-5-4-8	See Note #6
Fuel Pump Pressure	5 to 6 PSI	See Note #1
Oil Pan Capacity	4 Qts.	See Note #5

ALL NOTES APPEAR ON PAGE # SP 8

# SPECIFICATIONS

## PCM Engine Model PLP EFI (GT40)

Displacement CID/liter	351/5.8	
Bore (inches)	4.00"	
Stroke (inches)	3.50"	
Compression Ratio	8.3:1	
Horsepower @ 4,800 RPM	310	
Battery Recommended Min. CCA	350	See Note #4
Fuel Injection (Multi Point)	8 (24#)	
Spark Plug Number 14mm	AWSF22 (Motorcraft)	See Note #7
MAXIMUM (Intermittent) RPM's	4,800	See Note #9
Continuous Cruise RPM's (Max)	4,000 to 4,200	See Note #2
Idle Speed (in forward gear)	650 to 700 RPM	ECM Controlled
Distributor (Marine Approved)	Motorcraft Electronic	See Note #1
Ignition Timing @ 2,000 RPM	5° BTDC	See Note #3
Spark Plug Gap	.045"	
Firing Order	1-3-7-2-6-5-4-8	See Note #6
Fuel Pump (High Pressure injector)	39 (± 3) PSI	See Note #10
Fuel Pump (Low Pressure Feed)	5 to 6 PSI	See Note #1
Oil Pan Capacity	4 Qts.	See Note #5

ALL NOTES APPEAR ON PAGE # SP 8

# SPECIFICATIONS

## NOTES

- NOTE #1 This part is a special "MARINE APPROVED" part and is required by law to insure the safety of the public. Repair or replacement in a manner inconsistent with its original configuration or replacement with a non approved part is not only dangerous, but could be in violation of the law.
- NOTE #2 Do not cruise at high limits of above range, unless propped to turn at or near maximum RPM's, at full throttle.
- NOTE #3 A. Before setting ignition timing of EFI engines, the ECM on the GM TBI, must be set to the service mode and/or the SPOUT connector of the GT40, located near the engine oil fill tube, must be disconnected. Reconnect after setting timing.  
B. Unleaded fuel of proper octane is recommended. (\* See fuel requirements page # GN 3). Do not use fuels which contain methanol alcohol or more than 10% ethanol alcohol. If pinging and/or other pre-ignition or detonation signs are present, a mechanical problem may exist which requires immediate attention by a qualified marine technician.
- NOTE #4 CCA Ratings are absolute minimums. Larger batteries are better suited for longer life and owner satisfaction. **WARNING: DO NOT** reverse battery cables on battery terminals. DO NOT spark battery cables against terminals to check polarity. Damage to charging system components may result if these precautions are not observed.
- NOTE #5 When changing oil filter, run engine and add only enough oil to bring level back to full mark on dipstick to replenish amount used by the filter.
- NOTE #6 Spark plug wire routing diagrams are pictured on page # MT 11.
- NOTE #7 Numbers listed are MOTORCRAFT numbers. AUTOLITE equivalents are AUTOLITE # 303 or 3303 to replace MOTORCRAFT # ASF32M and AUTOLITE # 763 to replace MOTORCRAFT # AWSF 22.
- NOTE #8 6 Qt. at 0° & 5 Qt. at 15° (installed angle). Dipstick calibrated full at 15° and 1/4 above full and low mark on HP454 (LN). When changing oil filter, run engine and add only enough oil to bring level back to full mark on dipstick to replenish amount used by filter.
- NOTE #9 This PCM engine has electronic spark and RPM limiting control incorporated into the Electronic Control Module (ECM). Reduction in engine performance will be noted if excessive mechanical noise, detonation or spark knock is present.
- NOTE #10 Fuel pressure reading listed for multi point fuel injection, is checked with the key on and the *engine not running* or with the engine running with the vacuum hose *removed from the fuel pressure regulator*. Fuel pressure on PCM engines equipped with a TBI may be checked either while the engine is running or not running. There is no vacuum hose on the fuel pressure regulator of a PCM engine equipped with a TBI.
- NOTE #11 GM based engines with Delco ignition systems and ECM Controlled spark timing must be put into service mode before checking or setting the base timing. GM based engines with Delco ignition systems and distributor controlled timing (carburetor equipped, non TBI or MPI engines) require that *AFTER THE ENGINE IS STARTED AND RUNNING* an initial timing wire must be attached to a 12 volt B+ voltage source. Do not connect this wire to a 12 volt B+ voltage source until after the engine is running. If this wire is connected to a 12 volt B+ source while the engine is being started, the ignition control module (ICM) in the distributor may be damaged. If engine shuts off and must be restarted while this wire is connected to a 12 volt B+ source, *DETACH THIS WIRE BEFORE ATTEMPTING TO RESTART THE ENGINE*.

\* See page # GN1 for model information.

# FORMS

---

## TABLE OF CONTENTS

Transferable Warranty .....	FM1
Warranty Transfer Application .....	FM1
Ownership Change Information .....	FM2
Service Manual Ordering Information: .....	FM2
Operation And Maintenance Log .....	FM3
Operation And Maintenance Log .....	FM4
Problem Notification Or Information Request Form .....	FM5
Team PCM Add Ons And Extras .....	FM6

# FORMS

## TRANSFERABLE WARRANTY

The PCM Limited warranty is transferable to a subsequent purchaser, but only for the remainder of the unused portion of the warranty term. This will not apply to products used in commercial applications.

### DIRECT SALE BY OWNER

- The second purchaser can be registered as the owner and retain the unused portion of the warranty term by sending in the original owner's plastic Warranty Registration Card, page FM2 of this manual with OWNERSHIP CHANGE INFORMATION completed, a copy of the bill of sale showing the date sold to the second owner, as well as a completed Warranty Transfer Application.
- A new Warranty Registration Card will be issued to the second owner and the factory computer will reflect the change.
- There is a transfer fee which must be submitted via certified check with the Transfer Application to PCM, PO Drawer 369, Little Mountain SC, 29075. The amount of the transfer fee for engines built in the 1997 model year is \$ 100.00.

*OUTSIDE THE UNITED STATES AND CANADA, PLEASE CONTACT YOUR LOCAL PCM DEALER OR THE PCM WARRANTY SERVICES AT (803) 345-1337 FOR INFORMATION ON HOW TO APPLY FOR THIS PROGRAM*

## WARRANTY TRANSFER APPLICATION

**IMPORTANT! PURCHASER PLEASE NOTE:** The checks listed below are designed to insure the safety and satisfaction of you, the owner. Therefore, we require that the following checks be performed at your expense by a qualified technician prior to deliver. By signing the check list, the technician certifies that he has checked the installation and operation of the engine and finds it to be performing properly. The owner or his agent should perform similar inspections periodically to identify any potential problems before they occur and to have any suspected defects checked and corrected immediately.

### PRE DELIVERY CHECK LIST

**TECHNICIAN: PLEASE CHECK OFF ALL POINTS AND SIGN BELOW.**

- |  |   |  |
|--|---|--|
| <input type="radio"/> Engine oil, check              | <input type="radio"/> Check shaft alignment                   | <input type="radio"/> Check timing                 |
| <input type="radio"/> Drive lube, check              | <input type="radio"/> Check control adjustments               | <input type="radio"/> Check exhaust hoses & clamps |
| <input type="radio"/> Check battery charge and level | <input type="radio"/> Check control travel                    | <input type="radio"/> Check alternator for charge  |
| <input type="radio"/> Tighten all water lines        | <input type="radio"/> Tighten all drain plugs                 | <input type="radio"/> Set idle speed               |
| <input type="radio"/> Check all lube points          | <input type="radio"/> Check belts for tension                 | <input type="radio"/> Check prop size and rotation |
|  | <input type="radio"/> Check for leaks, water, oil and exhaust |  |

Engine Model: \_\_\_\_\_ Engine Serial: \_\_\_\_\_

Trans. Serial: \_\_\_\_\_ # of Engine Hours: \_\_\_\_\_

Date sold to 1st owner: \_\_\_\_\_ Date sold to 2nd owner: \_\_\_\_\_

I hereby certify that I have completed the predelivery checklist on engine # \_\_\_\_\_ and I have corrected any discrepancies or inconsistencies revealed by these checks. Date: \_\_\_\_\_

Technician's signature \_\_\_\_\_ Company Name \_\_\_\_\_

Purchaser's signature \_\_\_\_\_ Date: \_\_\_\_\_

# FORMS

## OWNERSHIP CHANGE INFORMATION

If you are the owner of a Pleasurecraft Marine engine on which the remaining warranty is being transferred or is out of warranty and would like to inform us of your ownership for notification purposes, please inform us of your ownership by filling out this OWNERSHIP CHANGE FORM and returning it to:

Pleasurecraft Marine Engine Company  
P.O. Drawer 369  
Little Mountain, SC 29075

1. Name \_\_\_\_\_

Address \_\_\_\_\_

City \_\_\_\_\_ State \_\_\_\_\_ Zip \_\_\_\_\_

2. I am the new owner of a Pleasurecraft Marine Engine(s) with the following identification numbers:  
(for location of numbers see your Owner's Manual)

Engine model            Single or Port \_\_\_\_\_ Starboard \_\_\_\_\_

Serial Number            Single or Port \_\_\_\_\_ Starboard \_\_\_\_\_

Gear Model            Single or Port \_\_\_\_\_ Starboard \_\_\_\_\_

Serial Number            Single or Port \_\_\_\_\_ Starboard \_\_\_\_\_

3. Previous Owner's:

Name \_\_\_\_\_

Address \_\_\_\_\_

City \_\_\_\_\_ State \_\_\_\_\_ Zip \_\_\_\_\_

Purchased from \_\_\_\_\_ Date \_\_\_\_\_

## SERVICE MANUAL ORDERING INFORMATION:

A Service Manual is available for your PCM Engine. The current cost of this manual is twenty (\$20.00) dollars. *Contacting your PCM dealer or PCM to determine if the price has changed prior to submitting this application will prevent delay in filling your order.* This manual covers the engine, drive systems and related components.

To order, please print the requested information on the attached form and return with a check payable to Pleasurecraft Marine Engine Company. The price quoted includes the cost of the manual and postage.  
Mail form and check to:

Pleasurecraft Marine Engine Company  
P.O. Drawer 369  
Little Mountain, SC 29075

Please send \_\_\_\_\_ copies of the PCM Engine Service Manual to:

Name \_\_\_\_\_

Address \_\_\_\_\_

City, State, Zip \_\_\_\_\_

Engine Serial Number \_\_\_\_\_







# FORMS

## PROBLEM NOTIFICATION OR INFORMATION REQUEST FORM

Important: All blanks must be completed to insure proper identification of your engine which is necessary to properly understand your request.

When completed mail this form to;

Pleasurecraft Marine  
PO Drawer 369  
Little Mountain, SC 29075

Engine Model \_\_\_\_\_ Engine/Drive Serial Number \_\_\_\_\_ / \_\_\_\_\_

### Owner Information

Name \_\_\_\_\_ Telephone (\_\_\_\_) \_\_\_\_\_

Address \_\_\_\_\_

City \_\_\_\_\_ State \_\_\_\_\_ Zip \_\_\_\_\_

Selling Dealer \_\_\_\_\_

Dealers Address \_\_\_\_\_

Date of Purchase \_\_\_\_\_ Boat Make \_\_\_\_\_ Length \_\_\_\_\_ Type \_\_\_\_\_

Gentlemen I would like to inform you of a problem I have experienced with the above engine. My problem is;

---

---

---

---

---

---

---

---

---

---

---

---

---

---

---

---

---

---

---

---

---

---

---

My boat is located at \_\_\_\_\_

Address \_\_\_\_\_ Telephone (\_\_\_\_) \_\_\_\_\_

City \_\_\_\_\_ State \_\_\_\_\_ Zip \_\_\_\_\_

Requestors Signature \_\_\_\_\_ Date \_\_\_\_\_

FORMS

# TEAM PCM

## ADD-ONS & EXTRAS

	Description	Part #	Price	Qty	Total
PCM Logo Cap	PCM logo on twill cap, Khaki dome w/black bill		\$ 12.95		
PCM Logo Tee Shirt	Says "Team PCM Performance Team Driver" Heavy-duty 100% cotton, short sleeve pocket tee. White with red and black logo and lettering	-sm	\$ 12.95		
		-med	\$ 12.95		
		-lg	\$ 12.95		
		-xlg	\$ 12.95		
		-xxlg	\$ 12.95		

Total Order \_\_\_\_\_

Send check or money order to: PLEASURECRAFT MARINE ENGINE COMPANY  
 PO DRAWER 369  
 LITTLE MOUNTAIN, SC 29075

PLEASE ALLOW 2 WEEKS FOR DELIVERY. SHIP TO:

Name: \_\_\_\_\_

Address: \_\_\_\_\_

\_\_\_\_\_

Daytime phone: \_\_\_\_\_ Date: \_\_\_\_\_



